



# ENGINEERING CHEMISTRY

DIPLOMA COURSE IN ENGINEERING  
FIRST AND SECOND SEMESTER

A Publication under  
Government of Tamilnadu  
Distribution of Free Textbook Programme  
(NOT FOR SALE)

Untouchability is a sin  
Untouchability is a crime  
Untouchability is a inhuman

DIRECTORATE OF TECHNICAL EDUCATION  
GOVERNMENT OF TAMILNADU

**Thiru. PRAVEEN KUMAR, I.A.S.,**  
Principal Secretary /Commissioner of Technical Education  
Directorate of Technical Education  
Guindy, Chennai- 600025.

**Dr.K.SUNDARAMOORTHY, M.E., Ph.D.,**  
Additional Director of Technical Education (Polytechnics)  
Directorate of Technical Education  
Guindy, Chennai- 600025

**Co-ordinator**  
**Er. R.Sornakumar M.E.,**  
Principal  
Dr. Dharmambal Government  
Polytechnic College for Women  
Tharamani, Chennai—113

**Convener**  
**Mrs.A.Meera**  
H.O.D (UG) / Chemistry  
Dr. Dharmambal Government  
Polytechnic College for Women  
Tharamani, Chennai—113

***Reviewer***

**Prof.Dr.J.SANTHANALAKSHMI**  
Head of the Department / Physical Chemistry  
University of Madras, Chennai-25.

**Authors**

**Dr.K.Mohan M.Sc.,M.Phil.,Ph.D.,**  
H.O.D (UG)/ Chemistry  
Sakthi Polytechnic College  
Sakthinagar, Erode—638 315.

**THIRU.K.SUBRAMANIAN**  
H.O.D(UG)/ Chemistry  
P.T.LEE.C.N.Polytechnic College,  
Vepey, Chennai –600 007

**THIRU.S.MAHALINGAM,**  
H.O.D(UG)/Chemistry  
Govt.Polytechnic College  
Thuvakudi, Trichy-22.

**THIRU.I.SYED AHAMED HUSSAIN**  
Lecturer/Chemistry  
Institute of chemical technology  
Taramani, Chennai-113.

**THIRU.K.HEMACHANDRAN**  
Senior Lecturer/chemistry  
C.P.C.L.Polytechnic college  
Manali, Chennai-68.

This book has been prepared by the Directorate of Technical Education This book has been printed on 60 G.S.M Paper Through the Tamil Nadu Text book and Educational Services Corporation
--



## FOREWORD

We are indeed very happy to present engineering chemistry book for diploma engineers.

Chemistry is the branch of science that deals with the study of matter, its composition, physical and chemical properties and applications.

It is important for engineers to have knowledge of chemistry as those may face problems in fields as diverse as design and development of new materials, quality control and environmental engineering that are basically chemistry oriented in nature.

Chemistry is the backbone in designing and understanding the nature of various engineering materials. Many advances in engineering and technology either produce a chemical demand like polymers, chemical developments for their application in powder metallurgy and alloys, preventing methods of pollution etc. Currently electronics and computer field require biopolymers and nano materials. Electrical engineers require proper conducting materials. Mechanical engineers are in search of micro fluids and civil engineers are looking for environment friendly materials.

This book in engineering chemistry is prepared for the students studying I Year Diploma in Engineering and Technology in Tamilnadu. This book is written in simple and easily understandable manner. Tabular columns, figures, and worked examples are given wherever necessary. At the end of each chapter, short answer questions and long answer questions are given. Test your understanding questions are given wherever required which will motivate the students for further study.

The authors are very much grateful to the Commissioner of Technical Education Chennai for his deep involvement and encouragement in preparing this syllabus and learning material. Thanks are due to officials of DOTE, Chennai for their timely help whenever needed.

Further suggestions and constructive criticisms for the improvement of this book are welcome

**AUTHORS**

**30014 ENGINEERING CHEMISTRY – I****DETAILED SYLLABUS****Contents: Theory**

<b>Unit</b>	<b>Name of the Topic</b>	<b>Hours</b>
<b>I</b>	<b>ATOMIC STRUCTURE, MOLECULAR MASS, ACIDS AND BASES</b>	
	<b>1.1 Atomic Structure</b> Atom – Definition – Fundamental particles of Atom – their Mass, Charge and Location – Atomic number and Mass number – Definition – Isotopes and Isobars – Definition with suitable examples – Formation of cation and anion by electronic concept of oxidation and reduction – Octet rule – Formation of electrovalent compound (NaCl) – Formation of covalent compound (NH <sub>3</sub> ).	<b>4 Hrs</b>
	<b>1.2 Molecular Mass</b> Molecule – Molecular Formula – Molecular Mass – Mole – Definition – Simple calculations – Avogadro's Hypothesis – Relationship between Molecular Mass and Vapour Density – Avogadro Number – Definition.	<b>4 Hrs</b>
	<b>1.3 Acids and Bases</b> Theories of Acids and Bases – Arrhenius Theory – Lowry – Bronsted Theory – Lewis Theory – Advantages of Lewis Theory – pH and pOH – Definition – Numerical problems – Indicator – Definition and Examples only – Buffer solution – Definition – Types of buffer solution with examples – Application of pH in Industries.	<b>5 Hrs</b>
<b>II</b>	<b>SOLUTIONS, COLLOIDS, NANO-PARTICLES</b>	
	<b>2.1 Solutions</b> Definition – Methods of expressing concentration of a solution – Molarity, Molality, Normality, Mole fraction and Percentage Mass – Simple problems.	<b>4 Hrs</b>
	<b>2.2 Colloids</b> True solution and Colloidal solution – Definition – Differences – Types of colloids – Lyophilic and Lyophobic colloids – Differences – Properties – Tyndall effect, Brownian movement, Electrophoresis and Coagulation – Industrial applications of colloids – Smoke Precipitation by Cottrell's method, Purification of water, Cleansing action of soap, Tanning of leather and Sewage disposal.	<b>6 Hrs</b>
	<b>2.3 Nano-Particles</b> Definition – Importance of Nano-particles – Area of application – Medicine, Electronics and Biomaterials.	<b>3Hrs</b>

Unit	Name of the Topic	Hours
III	<p data-bbox="316 237 1042 271"><b>TECHNOLOGY OF WATER, CATALYSIS, GLASS</b></p> <p data-bbox="316 311 683 344"><b>3.1 Technology of Water</b></p> <p data-bbox="316 347 1362 745">Sources of water – Reasons for depletion of underground water – Rain water harvesting (Basic ideas) – Advantages – Hard water and soft water – Hardness of water – Carbonate and Non-carbonate hardness – Methods of expressing hardness – mg/lit and ppm – Simple problems – Estimation of total hardness of water by EDTA method – Problems involving Total, Carbonate and Non-carbonate hardness in ppm – Softening of hard water – Ion-Exchange method and Reverse Osmosis method – Municipal water supply – Purification (Sedimentation, Filtration and Sterilization) – Disadvantages of using hard water in boilers – Scale formation, Corrosion of boiler metal, Caustic Embrittlement and Priming and Foaming.</p> <p data-bbox="316 768 507 801"><b>3.2 Catalysis</b></p> <p data-bbox="316 819 1362 965">Catalyst – Positive catalyst – Negative catalyst – Definition – Types of catalysis – Homogeneous and Heterogeneous – Promoter – Catalyst poison – Definition – Characteristics of a catalyst – Industrial applications of catalysts.</p> <p data-bbox="316 987 456 1021"><b>3.3 Glass</b></p> <p data-bbox="316 1039 1362 1106">Definition – Manufacture of Glass – Varieties of Glass – Optical Glass, Windshield Glass and Photo chromatic Glass.</p>	<p data-bbox="1390 311 1469 344"><b>6 Hrs</b></p> <p data-bbox="1390 790 1469 824"><b>4 Hrs</b></p> <p data-bbox="1390 969 1469 1003"><b>3 Hrs</b></p>
IV	<p data-bbox="316 1167 1233 1234"><b>ELECTROCHEMISTRY, ELECTROCHEMICAL CELL, ENERGY SOURCES</b></p> <p data-bbox="316 1274 627 1308"><b>4.1 Electrochemistry</b></p> <p data-bbox="316 1326 1362 1543">Electrolyte – Definition – Strong and Weak electrolytes – Examples – Electrolysis – Definition – Mechanism – Industrial application of Electrolysis – Electroplating – Preparation of surface – Process – Factors affecting the stability of the coating – Chrome plating – Electroless plating – Definition – Advantages of Electroless plating over electroplating – Applications of Electroless plating.</p> <p data-bbox="316 1565 679 1599"><b>4.2 Electrochemical Cell</b></p> <p data-bbox="316 1617 1362 1762">Electrochemical Cell – Definition – Representation of a Cell – Single Electrode Potential – Definition – Galvanic Cell – Formation of Daniel Cell – Electrochemical Series – Definition and Significance – Electrolytic Concentration Cell – Definition and Formation.</p> <p data-bbox="316 1785 611 1818"><b>4.3 Energy Sources</b></p> <p data-bbox="316 1836 1362 2013">Primary Battery – Definition and example – Construction, Working and Uses of Dry cell – Secondary Battery – Definition and example – Construction, Working and Uses of Lead-acid Storage Cell – Non-conventional Energy Sources – Solar Cell – Definition – Principle, Construction, Working and Uses.</p>	<p data-bbox="1390 1274 1469 1308"><b>5 Hrs</b></p> <p data-bbox="1390 1576 1469 1610"><b>4 Hrs</b></p> <p data-bbox="1390 1800 1469 1834"><b>4 Hrs</b></p>

Unit	Name of the Topic	Hours
V	<b>CORROSION, METHODS OF PREVENTION OF CORROSION, ORGANIC COATINGS</b>	
	<b>5.1 Corrosion</b> Definition – Types of Corrosion – Theories of corrosion – Galvanic Cell Formation Theory – Differential Aeration theory – Factors influencing the rate of corrosion.	<b>4 Hrs</b>
	<b>5.2 Methods of Prevention of Corrosion</b> Control of Environment – Alloying – Surface coatings – Metal coatings – Electroplating, Galvanization and Tinning – Inorganic coating – Anodizing – Cathodic Protection – Sacrificial Anode Method and Impressed Voltage Method.	<b>4 Hrs</b>
	<b>5.3 Organic Coatings</b> Paint – Definition – Components of Paints and their functions – Varnish – Definition – Preparation of Oil Varnish – Differences between Paint and Varnish – Special Paints – Luminescent Paints, Fire Retardant Paints, Aluminium Paints and Distemper.	<b>5 Hrs</b>

**Text Book:**

1. Engineering Chemistry – I Tamil Nadu Text Book Corporation
2. Engineering Chemistry – Jain & Jain – Dhanpat Rai & Sons.
3. A Text Book of Engineering Chemistry – S.S. Dara – S. Chand Publication.

**Reference Book:**

1. A Text Book of Environmental Chemistry and Pollution Control S.S. Dara – S. Chand Publication.
2. Engineering Chemistry – Uppal – Khanna Publishers.
3. Chemistry – Higher Secondary – Second Year – Volume I & II – Tamil Nadu Text Book Corporation – 2014.
4. Environmental Chemistry – V P Kudesia – Pragati Publishers.

**30025 ENGINEERING CHEMISTRY – II**  
**DETAILED SYLLABUS**

**Contents: Theory**

Unit	Name of the Topic	Hours
<b>I</b>	<p><b>ENVIRONMENTAL CHEMISTRY</b></p> <p><b>1.1 Air Pollution</b> Pollution and Air pollution – Definition – Air pollutants (SO<sub>2</sub>, H<sub>2</sub>S, HF, CO and Dust) – Sources and Harmful effects – Formation of Acid Rain – Harmful effects – Green House Effect – Causes – Global warming – Harmful effects – Ozone Layer – Importance – Causes for Depletion of Ozone Layer (No equations) – Harmful effects of Ozone Layer Depletion – Control of Air Pollution.</p> <p><b>1.2 Water Pollution</b> Causes of Water Pollution – Sewage, Effluents, Algae and Microorganisms – Harmful effects – Sewerage – Definition – Sewage Disposal – Industrial Effluents – Harmful effects of Effluents – Harmful effects of Heavy Metal Ions – Lead, Cadmium, Zinc and Copper – Treatment of Effluents – Eutrophication – Definition and harmful effects.</p> <p><b>1.3 Solid Waste Management</b> Solid Waste – Definition – Problems – Types of Solid Waste – Methods of disposal – Land fill and Incineration.</p> <p><b>1.4 Green Chemistry</b> Definition – Goals of Green Chemistry (Basic ideas) – Recycling – Definition – Examples – Advantages of Recycling (Basic ideas)</p>	<p><b>5 Hrs</b></p> <p><b>4 Hrs</b></p> <p><b>2 Hrs</b></p> <p><b>2 Hrs</b></p>
<b>II</b>	<p><b>FUELS, COMBUSTION AND REFRACTORIES</b></p> <p><b>2.1 Fuels</b> Fuel and fossil fuel – Definition – Calorific value – Classification of fuels – Solid fuels – Wood – Coal – Varieties of Coal – Composition – Specific uses – Liquid fuels – Petroleum – Fractional distillation – Fractions and uses – Cracking (Concept only) – Liquid Hydrogen as fuel – Gaseous fuels – Preparation, composition and specific uses of Producer gas and Water gas – Composition and uses of CNG and LPG – Relative advantages of solid, liquid and gaseous fuels.</p> <p><b>2.2 Combustion</b> Definition – Combustion calculation by mass (for solid and liquid fuels) – Combustion calculation by volume (for gaseous fuels) – Stoichiometric calculations – Volume of air required – Excess air – Definition of Flue gas – Flue gas Analysis – Orsat Apparatus – Simple numerical problems.</p> <p><b>2.3 Refractories</b> Definition – Requirements of a good Refractory – Classification – Acidic, Basic and Neutral Refractories – Examples and uses – Uses of Fireclay bricks, Alumina bricks and Silica bricks.</p>	<p><b>6 Hrs</b></p> <p><b>5 Hrs</b></p> <p><b>2 Hrs</b></p>

Unit	Name of the Topic	Hours
III	<p><b>EXTRACTION OF METALS, POWDER METALLURGY, ALLOYS AND ABRASIVES</b></p> <p><b>3.1 Extraction of metals</b> Extraction of Tungsten and Titanium – Uses of Tungsten and Titanium.</p> <p><b>3.2 Powder metallurgy</b> Definition – Preparation of Metal Powder – Atomization – Reduction of Metal Oxide – Applications of Powder Metallurgy.</p> <p><b>3.3 Alloys</b> Definition – Purpose of alloying – Types – Ferrous Alloys – Composition and uses of Stainless Steel, Chromium Steel and Vanadium Steel – Non-ferrous alloys – Composition and uses of Nichrome, Dutch metal, German silver, Gun metal and Duralumin.</p> <p><b>3.4 Abrasives</b> Definition – Classification – Hardness in Moh’s scale – Natural abrasives – Diamond, Corundum, Emery and Garnet – Synthetic abrasives – Carborundum – Boron carbide – Manufacture – Properties and uses.</p>	<p><b>2 Hrs</b></p> <p><b>3 Hrs</b></p> <p><b>4 Hrs</b></p> <p><b>4 Hrs</b></p>
IV	<p><b>CEMENT, CERAMICS, LUBRICANTS AND ADHESIVES</b></p> <p><b>4.1 Cement</b> Definition – Manufacture of Portland Cement – Wet Process – Setting of Cement (No equation).</p> <p><b>4.2 Ceramics</b> White pottery – Definition – Manufacture of White pottery – Uses – Definition of glazing – Purpose – Method – Salt glazing.</p> <p><b>4.3 Lubricants</b> Definition – Characteristics of Lubricant – Types of Lubricants – Solid – Semi-solid –Liquid Lubricants .</p> <p><b>4.4 Adhesives</b> Definition – Requirements of good adhesives – Natural adhesive – Uses of Shellac, Starch, Asphalt – Synthetic adhesive – Uses of Cellulose Nitrate, PVC, Phenol-formaldehyde and Urea-formaldehyde.</p>	<p><b>3 Hrs</b></p> <p><b>3 Hrs</b></p> <p><b>3 Hrs</b></p> <p><b>4 Hrs</b></p>



Unit	Name of the Topic	Hours
<b>V</b>	<b>POLYMERS</b>	
	<b>5.1 Plastics</b> Plastics – Definition - Polymerization – Definition – Types of polymerization – Addition polymerization – Formation of Polythene – Condensation polymerization – Formation of Bakelite – Types of plastics – Thermoplastics and Thermoset plastics – Differences – Mechanical properties of plastics – Advantages of plastics over traditional materials (Wood and Metal) –Reinforced or filled plastics – Definition – Advantages – Applications – Polymers in Surgery – Biomaterials – Definition – Biomedical uses of Polyurethane, PVC, Polypropylene and Polyethylene.	<b>6 Hrs</b>
	<b>5.2 Rubber</b> Definition – Preparation from Latex – Defects of natural rubber– Compounding of rubber – Ingredients and their functions – Vulcanization – Definition and Purpose – Reclaimed rubber – Definition – Process – Properties and uses.	<b>5 Hrs</b>
<b>5.3 Composite materials</b> Definition – Examples – Advantages over metals and polymers – General applications.	<b>2 Hrs</b>	

Text Book:

1. Engineering Chemistry – Jain & Jain – Dhanpat Rai & Sons.
2. A Text Book of Engineering Chemistry – S.S. Dara – S. Chand Publication.

Reference Book:

1. Chemistry of Engineering Material-C.V. Agarwal, Andranaidu C. Parameswara Moorthy – B.S. Publications.
2. Engineering Chemistry – Uppal – Khanna Publishers.
3. A Text Book of Inorganic Chemistry – P.L. Soni – S. Chand Publication.
4. Rain Water Harvesting – Hand Book – Chennai Metro Water.

## Board Examination - Question paper pattern

Time: 3 Hrs.

Max.Marks: 75

**PART A** - 5 Questions to be answered out of 8 for 2 marks each.

**PART B** - 5 Questions to be answered out of 8 for 3 marks each.

**PART C** - All the 5 Questions to be answered

Each question in PART C will contain 3 Sub questions, out of these 3 Sub questions 2 Sub questions is to be answered for 5 marks each.

<b>PART A</b>	<b>5 x 2 marks</b>	<b>10 Marks</b>
<b>PART B</b> Short answer type questions	<b>5 x 3 marks</b>	<b>15 Marks</b>
<b>PART C</b> Descriptive answer type questions Each question in PART C will contain 3 Sub questions, out of these 3 Sub questions 2 Sub questions is to be answered for 5 marks each.	<b>5 x 2 x 5 marks</b>	<b>50 Marks</b>
Total		<b>75 Marks</b>

Out of the 3 Sub questions in PART C, one sub question must be on problem based to test the analytical ability/logical ability /diagnostic ability/conceptual ability relevant to that subject content. Equal weightage is to be given to whole syllabus.

Clarks table will not be permitted for the Board Examinations.

**CONTENTS**  
**FIRST SEMESTER**

<b>UNIT</b>	<b>CONTENTS</b>	<b>Page No</b>
<b>UNIT-I</b>	<b>ATOMIC STRUCTURES, MOLECULAR MASS, ACIDS AND BASES</b>	
1.1	Atomic structure	<b>01</b>
1.2	Molecular Mass	<b>09</b>
1.3	Acids and Bases	<b>16</b>
<b>UNIT-II</b>	<b>SOLUTIONS, COLLOIDS, NANO PARTICLES</b>	
2.1	Solution	<b>24</b>
2.2	Colloids	<b>35</b>
2.3	Nano-Particles	<b>40</b>
<b>UNIT-III</b>	<b>TECHNOLOGY OF WATER CATALYSIS AND GLASS</b>	
3.1	Technology of water	<b>42</b>
3.2	Catalysis	<b>56</b>
3.3	Glass	<b>60</b>
<b>UNIT-IV</b>	<b>ELECTROCHEMISTRY, ELECTROCHEMICAL CELL AND ENERGY RE-SOURCES</b>	
4.1	Electrochemistry	<b>63</b>
4.2	Electrochemical cell	<b>69</b>
4.3	Energy Resources	<b>75</b>
<b>UNIT-V</b>	<b>CORROSION, METHODS OF PREVENTION OF CORROSION AND ORGANIC COATINGS</b>	
5.1	Corrosion	<b>81</b>
5.2	Methods of Prevention of corrosion	<b>89</b>
5.3	Organic Coatings	<b>96</b>
<b>ENGINEERING CHEMISTRY PRACTICAL -I SYLLABUS AND PROCEDURE</b>		<b>102</b>

## SECOND SEMESTER

UNIT	CONTENTS	Page No
<b>UNIT-I</b>	<b>ENVIRONMENTAL CHEMISTRY</b>	
<b>1.1</b>	Air Pollution	<b>142</b>
<b>1.2</b>	Water Pollution	<b>149</b>
<b>1.3</b>	Solid Waste Management	<b>154</b>
<b>1.4</b>	Green Chemistry	<b>158</b>
<b>UNIT-II</b>	<b>FUELS, COMBUSTION &amp; REFRACTORIES</b>	
<b>2.1</b>	Fuels	<b>160</b>
<b>2.2</b>	Combustion	<b>168</b>
<b>2.3</b>	Refractories	<b>184</b>
<b>UNIT-III</b>	<b>EXTRACTION OF METALS, POWDER METALLURGY ALLOYS AND ABRASIVES</b>	
<b>3.1</b>	Extraction of metals	<b>187</b>
<b>3.2</b>	Powder metallurgy	<b>191</b>
<b>3.3</b>	Alloys	<b>194</b>
<b>3.4</b>	Abrasives	<b>198</b>
<b>UNIT-IV</b>	<b>CEMENT, CERAMICS, LUBRICANTS AND ADHESIVES</b>	
<b>4.1</b>	Cement	<b>203</b>
<b>4.2</b>	Ceramics	<b>206</b>
<b>4.3</b>	Lubricants	<b>209</b>
<b>4.4</b>	Adhesives	<b>212</b>
<b>UNIT-V</b>	<b>POLYMERS</b>	
<b>5.1</b>	Plastics	<b>215</b>
<b>5.2</b>	Rubber	<b>222</b>
<b>5.3</b>	Composite materials	<b>226</b>
<b>ENGINEERING CHEMISTRY PRACTICAL-II SYLLABUS AND PROCEDURE</b>		<b>228</b>
<b>FIRST AID FOR ACCIDENTS IN CHEMISTRY LABORATORIES</b>		<b>249</b>

# ENGINEERING CHEMISTRY-I

## FIRST SEMESTER

### UNIT-I

#### ATOMIC STRUCTURES, MOLECULAR MASS, ACIDS AND BASES

##### 1.1 ATOMIC STRUCTURE

###### INTRODUCTION

**Chemistry is a branch of science that deals with the study of the nature of matter, its composition, occurrence, isolation, methods of preparation, properties and uses.**

An **atom** is the smallest form of a chemical particle that retains the properties of the particle. The word 'atom' comes from the Greek word 'atomos', meaning 'unable to be cut'. The original meaning of atom was the smallest, indivisible form of a chemical particle. Now we know how to divide atoms into sub-atomic particles, the definition of an atom includes the concept that the particle must retain its chemical properties.

###### ATOM

An Atom is the smallest invisible particle of element, having all the characteristics of the parent element, which can neither be created nor destroyed by any chemical change. It cannot exist freely. It is the ultimate particle of an element, which may or may not have independent existence.

The atoms of certain elements such as hydrogen, oxygen, nitrogen, etc. do not have independent existence where as atoms of helium, neon, argon, etc. do have independent existence. All elements are composed of atoms.

###### Fundamental particles of an atom

Almost the atoms of all elements are made up of three main particles known as fundamental particles. They are electrons, protons and neutrons. Hydrogen is the only element that do not have neutron.

###### PROTON

1. The proton is a positively charged particle.
2. It has unit positive charge and unit mass. The mass of proton is approximately equal to the mass of one hydrogen atom. It is equal to 1.00732 amu.
3. The proton is present in atoms of all the elements.
4. The protons are present inside the nucleus of an atom.

## **ELECTRON**

1. The electron is a negatively charged particle.
2. It has unit negative charge and negligible mass.
3. The mass of an electron is about  $1/1837$  of mass of a hydrogen atom.
4. Electrons are present in all the atoms.
5. Electrons are revolving around the nucleus in various circular orbits (shell).

## **NEUTRON**

1. The neutron is a neutral particle. Hence, it has no charge.
2. It has unit mass. The neutron is present in atoms of all elements except hydrogen. The mass of a neutron is slightly greater than the mass of a proton. It is equal to 1.00871 amu.
3. Neutron is present inside the nucleus of an atom.

## **ATOMIC NUMBER (Z)**

**The atomic number is the number protons present in the nucleus of an atom or number of electrons revolving around the nucleus in an atom.** Based on the carbon standard the atomic mass of an element may be defined as the ratio between the mass of one atom of the element and  $1/12^{\text{th}}$  of mass of an atom of carbon

Atomic number = No of protons = No of electrons

## **MASS NUMBER (A)**

The mass number of an element is given by the total number of protons and neutrons present in the nucleus of an atom.  $A = (P+N)$

Therefore the number of neutrons is  $= A - Z$ .

## **ISOTOPES**

The isotopes are atoms of the same elements having the same atomic number but different mass number.

e.g. Isotope of oxygen:  ${}_8\text{O}^{16}$ ,  ${}_8\text{O}^{17}$ ,  ${}_8\text{O}^{18}$ .

## **ISOBAR**

Isobars are the atoms of different elements having the same mass number but different atomic number.

e.g.  ${}_{92}\text{U}^{234}$ ,  ${}_{91}\text{Pa}^{234}$ .

## **STRUCTURE OF ATOM**

The atom consists of two parts. They are 1. The central nucleus 2. The outer extra nuclear part.

### **1. The central Nucleus:**

The nucleus is the central part of an atom consists of protons and neutrons. Since the protons are positively charged particle and neutrons are neutral, the nucleus is always positive part of an atom. The entire weight of an atom is present only in the nucleus.

## 2. The outer extra nuclear part.

1. It is the part around the nucleus. It contains all electrons of an atom. It is the negative part of the atom. The electrons are revolving around the nucleus in a regular path called shell or orbit or energy levels.
2. The shells or orbits are numbered, as 1,2,3,4 etc from the nucleus. They are also known as K, L, M, N Shell or orbit.
3. Each shell can accommodate only certain number of electron, which is given by the formula  $2n^2$  where the 'n' is the number of the shell. Therefore, the numbers of electrons that are accommodated in the 1st, 2nd, 3rd shell respectively are 2,8,18.
4. The electrons present in the outer most orbit is called as **valence electron**.
5. The atom as whole is a neutral one. Since the number of protons (positively charges) is equal to the number of electrons (negative charges).

The atomic structure of Sodium atom is given below.

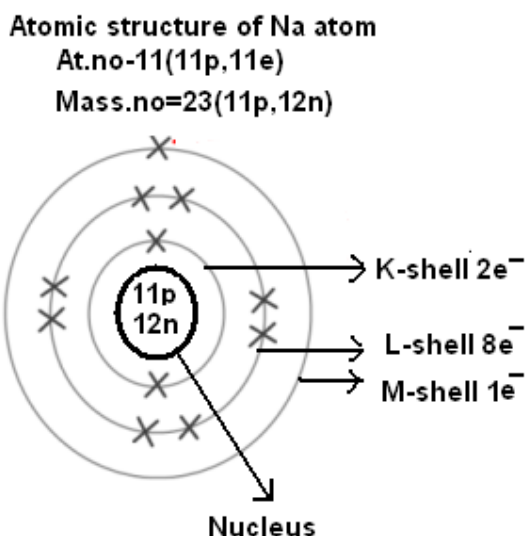

## FORMATION OF CATION AND ANION

### Example.1

#### 1. Hydrogen atom

Number of proton = 1 (number of positive charge is +1)

Number of electron = 1 (number of negative charge is -1)

Number of neutron = 0

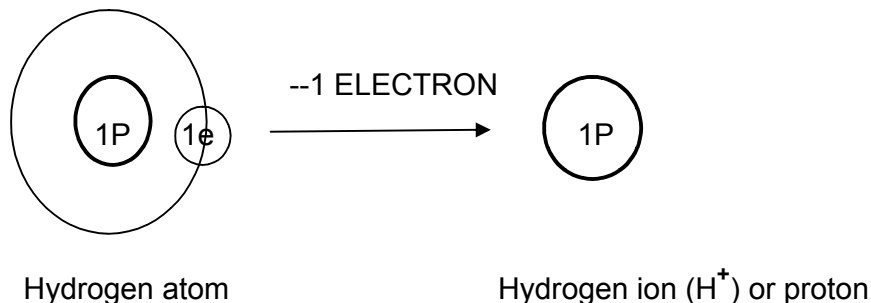

So,  $Z=1$  ,  $A=1$

When hydrogen atom loses its outer most electron, it has only one proton. The H becomes  $H^+$  ion due to the loss of one electron. Hence, the  $H^+$  ion is called as proton.

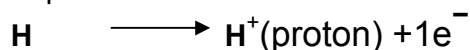

$A-Z=1-1=0$ (No neutron)

### FORMATION OF CATION AND ANION

Atom as whole is a neutral one, since the number of proton and electrons are equal. An atom becomes an ion only when there is a gain or loss of an electron. Anion (-ve ion) is formed by the gain of electron. Similarly, cation (positive) is formed by the loss of electron.

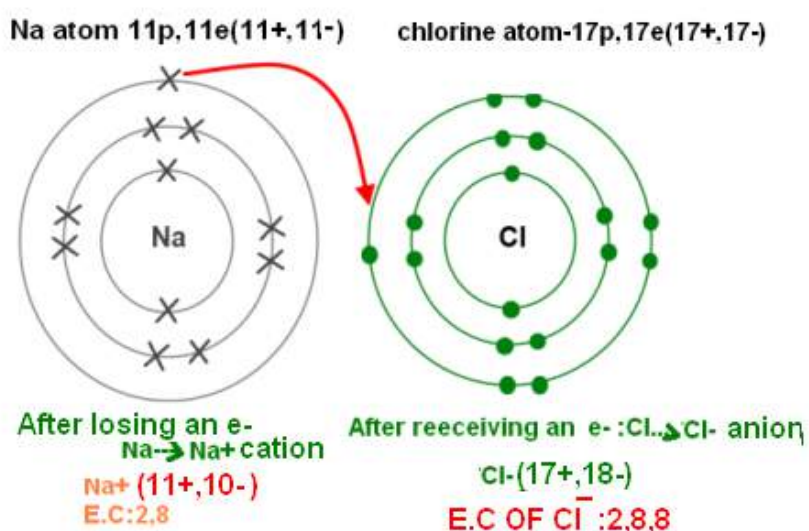

### CATION FORMATION

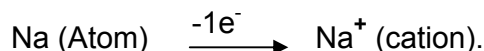

When an atom loses an electron it becomes cation. When electron is transferred from sodium atom to chlorine atom the sodium atom becomes cation.

### ANION FORMATION

When an atom gains an electron, it becomes anion. From the above example, chlorine atom gains an electron from sodium it becomes an anion.



### ELECTRONIC CONCEPT OF OXIDATION AND REDUCTION

The electronic concept of oxidation and reduction can be explained as below.

### OXIDATION

Oxidation is a process that involves removal (loss) of electrons.

**Example:**

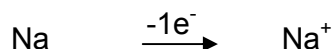



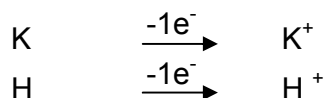

Here Na, K and H are oxidised into  $\text{Na}^+$ ,  $\text{K}^+$  and  $\text{H}^+$  respectively.

### **REDUCTION**

Reduction is a process that involves addition (gain) of electrons.

**Example:**

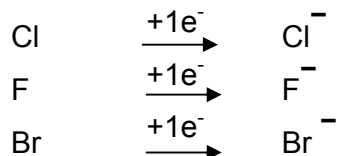

Here Cl, F and Br are reduced into  $\text{Cl}^-$ ,  $\text{F}^-$  and  $\text{Br}^-$  respectively.

### **What is chemical bonding?**

When two atoms in a molecule strongly tend to remain together, they are said to be in chemical bonding with each other. In other words, it is said that a chemical bond has been established between the two atoms. Thus,

**“A chemical bond may be defined as an attraction between the two atoms in a molecule”**

### **Why do atoms combine?**

There is a deep relationship between the properties and the electrons lying in their outermost orbits. The elements having same number of valency electrons have similar properties. The elements in the zero groups have two or eight electrons are inactive chemically.

### **OCTET RULE**

The inert gases have the stable configuration of eight electrons (octet structure) in their outer most orbits except helium which 2 have only electrons. Due to their stable octet structure, these gases are inert in nature. They do not chemically react with other elements. "According to Lewis **“octet theory, all the elements with an unstable or incomplete electronic configuration have a tendency to attain the stable electronic configuration of the nearest inert gas configuration either by complete transfer of valence electron from one atom to another or by mutual sharing of valence electron between the atoms”**". This tendency to attain the stable electronic configuration is responsible for the formation of **chemical bonding**.

### **INERT GASES OR NOBLE GASES**

Element	Atomic number	Electronic configuration
Helium	2	<b>2 (H-1 unstable-for stable-2)</b>
Neon	10	<b>2,8</b>
Argon	18	<b>2,8,8</b>
Krypton	36	<b>2,8,18,8</b>
Xenon	54	<b>2,8,18,18,8</b>
Radon	86	<b>2,8,18,32,18,8</b>



Sodium has one electron in excess of the stable neon configuration (2, 8). and chlorine is one electron short of the stable argon configuration (2, 8, 8).

When these atoms are in contact, sodium has a tendency to lose its single valence electron and chlorine has a tendency to accept a single electron to reach the stable electronic configuration of the nearest inert gas. By transferring one electron from sodium to chlorine, sodium acquires a unit positive charge while by gaining the electron; the chlorine atom acquires a unit negative charge.

Now sodium has attained the stable electronic configuration of neon (2,8). Similarly chlorine has attained the stable electronic configuration of neon(2,8,8).

These charged ions are held together by electrostatic attraction and form a neutral molecule of sodium chloride.



Compounds formed in this way are called electrovalent or ionic compounds and the bond is called ionic bond or electrovalent bond.

### Covalent bond

#### Formation of a covalent compound(NH<sub>3</sub>)

This type of bond is formed by the mutual sharing of pair of electrons between two atoms each atom supplying equal number of electrons for sharing. The covalent bond is indicated by (-).

**Example** : Formation of Ammonia (NH<sub>3</sub>).

**Explanation** :

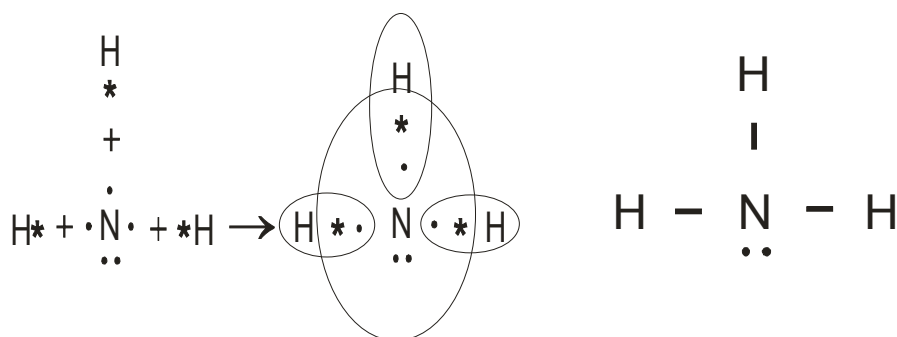

The atomic no of Nitrogen is 7. (E.C:2, 5 unstable)

The electronic configuration  $1s^2, 2s^2, 2p^3$ .

The electron dot formula of N is  $\begin{array}{c} \cdot \\ \text{N} \\ \cdot \end{array}$

The electron dot formula is  $\text{H}\cdot$

The atomic number of Hydrogen is 1.

The electronic configuration  $1s^1$  (E.C:1 unstable)

To get stable electronic configuration Nitrogen shares its three electrons with electrons of three Hydrogen atoms.

Ammonia is formed by the covalent bonding between one atom of nitrogen and three atoms of hydrogen. Nitrogen has five valence electrons. The electronic configuration is  $2,5$  (unstable). Therefore, it needs three electrons to attain stable inert gas configuration. Hydrogen has one electron. So it needs one electron to attain the stable inert gas configuration of Helium. The nitrogen atom shares three of its valence electrons with three hydrogen atoms forming the covalent bonds.

All the four atoms attain the stable configuration. Thus, the covalent bond is formed.

## QUESTIONS

### PART-A

1. What is the charge of a nucleus of an atom?
2. Define isotopes
3. Define isobars
4. What is the charge of an anion?
5. What is the charge of a cation?
6. Define oxidation
7. Define reduction

### PART-B

1. We can call  $\text{H}^+$  ion as a proton. How?
2. Atomic number and mass number of an element is 9 & 19 respectively. What is the number of neutrons present in the atom of the element?
3. Explain the formation of a cation with example?
4. Explain the formation of an anion with example?

### PART-C

1. Why do atoms of elements combine?
2. Which is more stable Na or  $\text{Na}^+$  Why?
3. Explain the formation of NaCl?
4. Explain the formation of  $\text{NH}_3$ ?
5. While atoms of most of the elements are unstable but atoms of noble gases are stable. Explain?
6. Which is more stable Cl or  $\text{Cl}^-$  Why?

## 1.2. MOLECULAR MASS

### Introduction

Chemistry is chiefly concerned with atoms and molecules and their interactions and transformations, for example, the properties of the chemical bonds formed between atoms to create chemical compounds or molecule. As such, chemistry studies the involvement of electrons and various forms of energy in chemical reactions.

### Molecule:

A Molecule is the smallest particle of matter(element or a compound) that can exit freely. The molecule is made up of two or more atoms of the same element or different elements. It can be further divided into atoms.

Types of molecules:

Molecules are of two types

1. Homoatomic molecules
2. Heteroatomic molecules

#### 1. Homoatomic molecule

The molecule is made up of two or more atoms of the same elements. Molecules of Chlorine( $\text{Cl}_2$ ), Oxygen( $\text{O}_2$ ), and Hydrogen( $\text{H}_2$ ) contain only two atoms of same kind. So they are called as Homoatomic molecules.

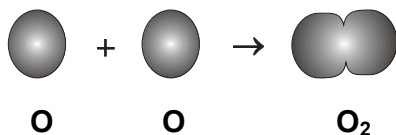
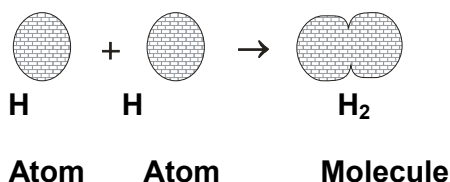

Most of the elementary gases consist of homoatomic molecules. For example hydrogen gas consists of two atoms of hydrogen ( $\text{H}_2$ ). Similarly oxygen gas consists of two atoms of oxygen ( $\text{O}_2$ ).

In accordance with the number of atoms present in these molecules they are classified as mono atomic, di-atomic, tri-atomic and polyatomic molecules showing that they contain one, two, three, or more than three atoms respectively.

#### 2. Heteroatomic molecules

The molecule is made up of more than two of more atoms of different elements. Thus in the molecule of carbon dioxide one atom of carbon & two atoms of oxygen have united. Hence, it is called as Heteroatomic molecules.

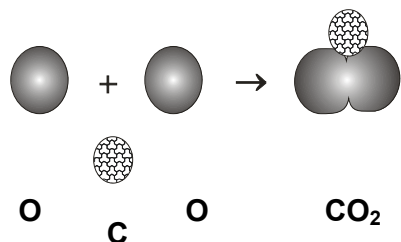

## MOLECULAR FORMULA

Molecular formula is the short form of representation (symbolical) of one molecule of an element or a compound.

**Example:** Molecular formula of Oxygen is  $\text{O}_2$  (element.).

Molecular formula of water is  $\text{H}_2\text{O}$  (compound)

### Significance of molecular formula

1. It shows the elements present in one molecule.
2. It gives the exact number of atoms present in one molecule.
3. It is used to calculate the molecular mass of a molecule.

### MOLECULAR MASS:

Molecular mass of an element or a compound is the ratio between the mass of one molecule of the element or the compound and the mass of 1/12 part of a carbon Atom.

$$\left. \begin{array}{l} \text{Molecular} \\ \text{Mass of an} \\ \text{Element /} \\ \text{Compound} \end{array} \right\} = \frac{\text{Mass of one molecule of an element or compound}}{1/12 \text{ part by mass of carbon}}$$

### Calculation of Molecular Mass:

Molecular mass can be calculated as the sum of total atomic mass of each element present in one molecule of an element or a compound.

#### Example:

$$\begin{aligned} \text{Molecular mass of } \text{O}_2 &= \text{Atomic mass} \times \text{No of atoms} \\ (\text{Oxygen}=16) & \end{aligned}$$

$$= 16 \times 2 = 32$$

$$\text{Molecular mass of } \text{NH}_3 = (14 \times 1) + (1 \times 3) = 17$$

$$(\text{Atomic mass of Nitrogen} = 14, \text{Hydrogen}=1)$$

## MOLE:

If the molecular mass is expressed in grams, then it is called gram molecular mass or one mole. The **mole** is a unit of measurement used in chemistry to express amounts of a chemical substance. One mole of any substance contains Avagadro number of particles i.e.,  $6.023 \times 10^{23}$  particles. (Atom, ion or molecules).

$$\text{Number of Moles} = \frac{\text{Mass in grams}}{\text{Molecular Mass}}$$

### **Example:**

$$\begin{aligned} \text{Molecular mass of O}_2 &= 32 \\ \text{Gram molecular mass of O}_2 &= 32\text{gms} \\ 32 \text{ gms of O}_2 &= 1 \text{ mole of O}_2 \\ &2 \text{ mole of O}_2 = 64 \text{ g.} \end{aligned}$$

### **Problem: 1**

How many moles are represented by 4.4 Gms. of  $\text{CO}_2$ ?

$$\begin{aligned} \text{At. Mass of Carbon} &= 12 \\ \text{At. Mass of Oxygen} &= 16 \\ \text{Molecular mass of CO}_2 &= (12 \times 1) + (16 \times 2) \\ &= 12 + 32 \\ &= 44 \end{aligned}$$

$$\text{No of moles} = \frac{\text{Mass in gm}}{\text{Molecular mass}}$$

$$\text{Thus no of moles of CO}_2 = \frac{4.4}{44} = \mathbf{0.1 \text{ mole}}$$

### **Problem: 2**

How many moles are present in 8.5gms of Ammonia?

$$\begin{aligned} \text{At. Mass of Nitrogen} &= 14 \\ \text{At. Mass of Hydrogen} &= 1 \\ \text{Molecular mass of Ammonia (NH}_3) &= (14 \times 1) + (1 \times 3) \\ &= 17 \end{aligned}$$

$$\text{No of moles} = \frac{\text{Mass}}{\text{Molecular mass}}$$

$$= \frac{8.5}{17} = 0.5$$

NO of moles present in 8.5 of Ammonia = **0.5**

**Problem: 3**

How many grams of SO<sub>2</sub> are present in 0.4 moles of SO<sub>2</sub> ?

Atomic Mass of Sulphur	=	32
Atomic Mass of Oxygen	=	16
Molecular mass of SO <sub>2</sub>	=	(32 x 1) + (2 x 16)
	=	64
Gram molecular mass of SO <sub>2</sub>	=	64g
1 mole	=	64g
∴ 0.4 Moles	=	64 x 0.4
	=	<b>25.6g</b>

**Problem: 4**

How many moles of Carbon atoms are present in three moles of C<sub>3</sub> H<sub>8</sub>?

1 mole of C<sub>3</sub> H<sub>8</sub> has 3 moles of carbon

∴ 3 moles of C<sub>3</sub>H<sub>8</sub> will have 9 moles of carbon atoms.

**AVOGADRO'S HYPOTHESIS**

Avogadro's Hypothesis states that, "Equal volumes of all gases contain the same number of molecules at the same temperature and pressure".

**Relationship between Molecular Mass & Vapour Density**

**Vapour Density :-**

Vapour Density of a gas is the ratio between the mass of certain volume of the gas & the mass of the same volume of hydrogen at the same temperature and pressure.

$$\text{Vapour Density} = \frac{\text{Mass of certain volume of a gas}}{\text{Mass of same volume of hydrogen at S.T.P}}$$

Let there be 'n' molecules in certain volume of a gas

$$\text{Vapour Density} = \frac{\text{Mass of 'n' molecules of a gas}}{\text{Mass of 'n' molecules of hydrogen}}$$

Let n = 1



$$\text{Vapour Density} = \frac{\text{Mass of 1 molecule of a gas}}{\text{Mass of 1 molecule of hydrogen}}$$

Mass of 1 molecules of hydrogen = 2 (mass of two atoms of hydrogen)

$$\text{Vapour Density} = \frac{\text{Mass of 1 molecule of a gas}}{2}$$

2 x vapour density = Mass of one molecule of a gas

i.e. **2 x Vapour Density = Molecular mass**

### **AVOGADRO NUMBER**

It can be defined as “**the number of atoms or molecules present in one mole of an element or a compound respectively**”. It is denoted by N. It has been found to be equal to  **$6.023 \times 10^{23}$** .

We have seen that, according to one of the applications of Avogadro’s hypothesis, one molecular mass (i.e. one mole) of every gas occupies 22.4 litres at S.T.P.

Now according to Avogadro’s hypothesis equal volumes of all gases at S.T.P contain equal number of molecules.

Hence it follows that 1 mole of every gas contains the same number of molecules. This number is called the Avogadro’s number or Avogadro’s Constant. It is denoted by N. It has been found to be equal to  $6.023 \times 10^{23}$ . **It can be defined as “the number of atoms or molecules present in one mole of an element or a compound respectively”.**

#### **Example**

One mole of CO<sub>2</sub> = 44g

44 g of CO<sub>2</sub> contains  $6.023 \times 10^{23}$  molecules

One molar volume of CO<sub>2</sub> = 22.4 liter

22.4 liter of CO<sub>2</sub> contains  $6.023 \times 10^{23}$  molecules

One mole of H<sub>2</sub>O = 18g

18 gms of H<sub>2</sub>O contains  $6.023 \times 10^{23}$  molecules

One mole of Oxygen atom = 16g

16 gms of Oxygen contains  $6.023 \times 10^{23}$  atoms

#### **Problem: 1**

How many molecules are present in 49g of H<sub>2</sub>SO<sub>4</sub>?

$$\begin{aligned}
 \text{One mole of H}_2\text{SO}_4 &= (2 \times 1) + (1 \times 32) + (4 \times 16) \\
 &= 2 + 32 + 64 \\
 &= 98\text{g}
 \end{aligned}$$

$$\begin{aligned}
 \text{No of molecules in 98g of H}_2\text{SO}_4 &= 6.023 \times 10^{23} \\
 \therefore \text{No of molecules in 49g of H}_2\text{SO}_4 &= \frac{6.023 \times 10^{23} \times 49}{98} \\
 &= \mathbf{3.0115 \times 10^{23}}
 \end{aligned}$$

**Problem: 2**

Calculate the mass of an atom of Carbon?

$$\begin{aligned}
 \text{One mole of Carbon atoms} &= 12\text{g} \\
 \text{Mass of } 6.023 \times 10^{23} \text{ atoms of Carbon} &= 12\text{g} \\
 \text{Mass of one atom of Carbon} &= \frac{12}{6.023 \times 10^{23}} \\
 &= \mathbf{1.992 \times 10^{-23} \text{ g}}
 \end{aligned}$$

**Problem: 3**

What is the mass of a molecule of Ammonia?

$$\begin{aligned}
 \text{One mole of Ammonia (NH}_3\text{)} &= 17\text{g} \\
 \text{Mass of } 6.023 \times 10^{23} \text{ molecules of NH}_3 &= 17\text{g} \\
 \text{Mass of one molecule of NH}_3 &= \frac{17}{6.023 \times 10^{23}} \\
 &= \mathbf{2.882 \times 10^{-23} \text{ g.}}
 \end{aligned}$$

**Problem: 4**

Calculate the number of atoms present in 64g of O<sub>2</sub>

$$\begin{aligned}
 \text{One mole of Oxygen atom} &= 16 \text{ g} \\
 \text{No of atoms in 16g of O}_2 &= 6.023 \times 10^{23} \\
 \text{No of atoms in 64gm of O}_2 &= \frac{6.023 \times 10^{23} \times 64}{16} \\
 &= \mathbf{24.092 \times 10^{23}}
 \end{aligned}$$

**PROBLEMS (3Marks)**

1. Calculate the molecular mass for the following
  - a) Sulphuric acid (H<sub>2</sub>SO<sub>4</sub>)
  - b) Water (H<sub>2</sub>O )
  - c) Carbon dioxide (CO<sub>2</sub>)
  - d) Sodium carbonate (Na<sub>2</sub>CO<sub>3</sub>)

2. How many moles are present in
- a) 220 g of carbon-dioxide
  - b) 72 g of water
  - c) 196g of sulphuric acid
  - d) 3 moles of ammonia
  - e) 2.5 moles of sulphuric acid
  - f) 1.5 moles of carbon dioxide
3. How many molecules are present in the following?
- a) 4g of nitrogen
  - b) 16g of oxygen
  - c) 32g of methane
4. What is the mass of the following
- a) One molecule of  $\text{CO}_2$
  - b) One molecule of  $\text{H}_2\text{O}$
5. Which one is heavier in the following at STP?
- a) 3 moles of  $\text{H}_2\text{O}$  (OR) 1 mole of  $\text{H}_2\text{SO}_4$

### QUESTIONS

#### PART- A

1. Define molecule.
2. Define molecular mass of a substance.
3. Define mole.
4. What is molecular formula?
5. Define Avogadro's number.

#### Part-B

1. State Avogadro's hypothesis.

#### PART-C

1. What are the applications of Avogadro's hypothesis?

## 1.3- ACIDS AND BASES

### INTRODUCTION

Depending upon the ions produced in the solution, the substances are classified into acids and bases. The acidic and basic nature of matter is more essential to study about the chemical reactions.

### ACIDS

An acid is a substance that gives hydrogen ions ( $H^+$ ) by itself or in aqueous solution.

**Example:**

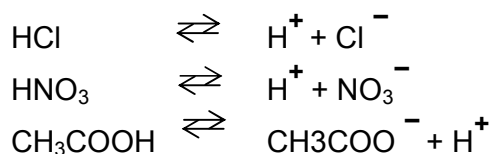

### BASES

A base is a substance that gives ions ( $\text{OH}^-$ ) by itself or in aqueous solution.

**Example:**

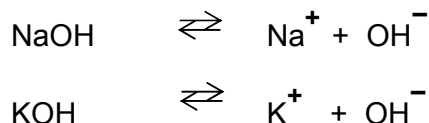

### THEORIES OF ACIDS AND BASES

By the following theories, the acidic and basic nature of substances can be easily explained

1. Arrhenius theory
2. Lowry-Bronsted theory
3. Lewis theory.

#### 1. Arrhenius Theory (1827)

According to this theory, **an acid is a substance that gives hydrogen ( $H^+$ ) ions in water or in aqueous solution.**

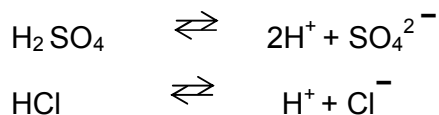

HCl gives  $H^+$  in water, hence it is called as acid.

**A Base is a substance that gives hydroxyl ions in water or in aqueous solution**

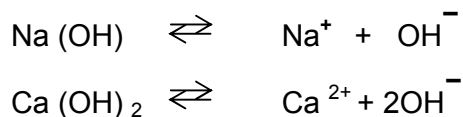

NaOH gives OH<sup>-</sup> in water; hence, it is called as base.

Strength of an acid (or) base depends upon the extent to produce H<sup>+</sup> (or) OH<sup>-</sup> during ionization.

### LIMITATIONS

1. It is valid only in aqueous solution or water-soluble acid and bases.
2. It is difficult to explain the basic properties of non-hydroxyl compounds like NH<sub>3</sub>, Na<sub>2</sub>CO<sub>3</sub>.

### LOWRY-BRONSTED THEORY (1923) (PROTONIC CONCEPT)

An Acid is a substance, which donates proton to any other substances. Hence, it is proton donor. eg. HCl, H<sub>2</sub>SO<sub>4</sub>.

A Base is substance that accepts proton from any other substance. Hence, it is proton acceptor. Eg. NH<sub>3</sub>

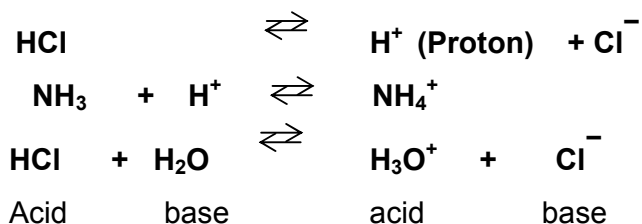

In the above example, the HCl gives proton to water. Hence it is called acid. The HCl and Cl<sup>-</sup> differ by only one proton. Hence they are called as conjugate acid-base pair.

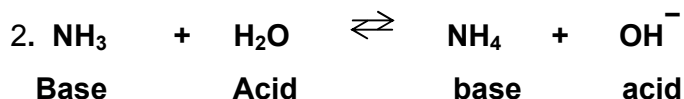

Similarly the NH<sub>3</sub> accepts proton from water, hence it is called base. The NH<sub>3</sub> and H<sub>2</sub>O differ by only one proton. Hence they are called as conjugate acid-base pair.

The water behaves like an acid and a base. Hence it is amphoteric in nature.

### Drawbacks

1. It explains the acidic and basic characters of a substance only if a solvent like water is present.
2. It does not explain the neutralization of acidic oxides (CO<sub>2</sub>, SO<sub>2</sub>) by basic oxides (CaO, BaO) because there are no H<sup>+</sup> ions.
3. It cannot explain the acid –base reaction in fused state and vapour state.

### Lewis Theory (1923)-(Electronic concept)

Lewis concept is known as electronic concept because it involves electron pair transfer during base formation.

illustration with Examples:1

According to this theory, an acid is a substance that accepts a pair of electrons. So, acid is an **electron pair acceptor**.

A base is a substance that donates a pair of electrons. So, base is an **electron pair donor**.

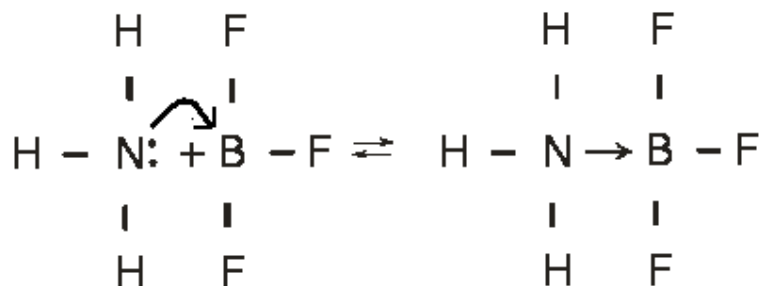

Ammonia donates a pair of electron to Boron trifluoride and is called as Lewis acid. Hence it is called as electron pair donor.

Born trifluoride accepts the electron pair from ammonia. Hence it is called as Lewis acid.

### Example:2

A **Lewis base** is an electron pair donor. This definition is more general than those we have seen to this point; any Arrhenius acid or base and any Bronsted-Lowry acid or base can also be viewed as a Lewis acid or base. The reaction of  $\text{H}^{1+}$  with  $\text{OH}^{1-}$ , for instance, involves donation and acceptance of a proton, so it is certainly legitimate to call it a Bronsted-Lowry acid-base reaction. But if we look at the Lewis structures for the reactants and products, we see that it is also legitimate to call this a Lewis acid-base reaction.

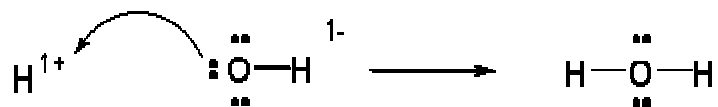

Here,  $\text{OH}^-$  donates pair of electrons. So, it is a base.  $\text{H}^+$  accepts a pair of electrons. So, it is an acid.

### Example: 3

#### Lewis acid

An acid is a substance that accepts a pair of electrons. So, acid is an **electron pair acceptor**.

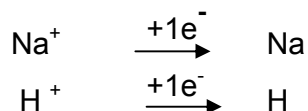

$\text{Na}^+$  ions is ready to accept an electron, hence it is called as Lewis acid.

#### Lewis base

A base is a substance that donates a pair of electrons. So, base is an **electron pair donor**.

**Example:**

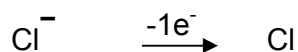

Here  $\text{Cl}^-$  is ready to donate an electron, hence it is called as Lewis base.

### ADVANTAGES

1. It explains the acid base reactions by way of electron transfer.
2. It gives an idea about the acidic character of substances that do not contain hydrogen. The acidic nature of the following substances like  $\text{BF}_3$ ,  $\text{FeCl}_3$ , and  $\text{AlCl}_3$  can be easily explained by this concept.
3. The neutralization of acidic oxides and basic oxides can also be easily explained by this concept.

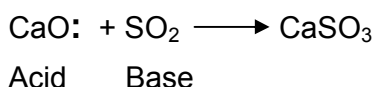

4. The concept can be easily understood.

### CONCEPT OF $p^H$ AND $p^{OH}$ (S.P.L Sorenson)

$P^H$  is a convenient way of expressing acidity or the concentration of  $H^+$  in solution. It helps to avoid the use of large of negative power of 10.

$$p^H = -\log_{10} [H^+] = \log_{10} \frac{1}{[H^+]}$$

$$[H^+] = 10^{-p^H}$$

Higher the concentration of  $H^+$ , lower will be the value of  $P^H$ .

#### DEFINITION $p^H$ and $p^{OH}$

$P^H$  of a solution is defined as negative of logarithm to the base 10 of the hydrogen ion concentration  $[H^+]$

$$p^H = -\log_{10} [H^+].$$

Similarly,

$P^{OH}$  of a solution is defined as negative of logarithm to the base 10 of the hydroxyl ion concentration  $[OH^-]$

$$p^{OH} = -\log_{10} [OH^-].$$

In a neutral aqueous solution

$$[H^+] \times [OH^-] = 10^{-14} \text{ gm ions/litre.}$$

$$\log_{10}[H^+] + \log_{10}[OH^-] = \log 10^{-14} = -14$$

$$-\log [H^+] + \{-\log [OH^-]\} = 14.$$

So,

$$p^H + p^{OH} = 14$$

**Problem.**

1. If pH of a solution is 5, what is its pOH? (Oct 2014).

$$\begin{aligned} p^H + p^{OH} &= 14 \\ 5 + p^{OH} &= 14 \\ p^{OH} &= 14 - 5 \\ p^{OH} &= 9 \end{aligned}$$

**IONIC PRODUCT OF WATER**

The product of  $[H^+]$  and  $[OH^-]$  is known as ionic product of water. The value is  $1 \times 10^{-14}$ .

$$\begin{aligned} K_w &= [H^+] \times [OH^-] \\ &= 1 \times 10^{-7} \times 1 \times 10^{-7} \\ &= 1 \times 10^{-14} \text{ g ions/litre.} \end{aligned}$$

**POINTS TO BE REMEMBERED**

1. For pure water,  $p^H$  and  $p^{OH}$  values = 7
2. The sum of  $p^H$  and  $p^{OH}$  should be equal to 14  
$$p^H + p^{OH} = 14.$$
3. Ionic product of water is  $1 \times 10^{-14}$ .
4.  $p^H = < 7$  Acid  
 $p^H = 7$  Neutral  
 $p^H = > 7$  Base

**PROBLEMS**

1. Calculate the pH of a solution whose hydrogen ion concentration is  $4.6 \times 10^{-4}$  gm ions/litre.

$$\begin{aligned} p^H &= -\log_{10} [H^+] \\ &= -\log_{10} [4.6 \times 10^{-4}] \\ &= -[\log_{10} 4.6] + [\log_{10} 10^{-4}] \\ &= -[0.6627 - 4] \\ &= -[-3.3373] \\ p^H &= 3.3373 \end{aligned}$$

2. Calculate the pH of 0.003M HCl solutions. The hydrogen ion concentration is 0.003

$$\begin{aligned} p^H &= -\log_{10} [H^+] \\ &= -\log_{10} [1 \times 10^{-3}] \end{aligned}$$



$$\begin{aligned}
 &= -\log_{10} [1] + \log_{10} [10^{-3}] \\
 &= - (0-3) \\
 \text{p}^{\text{H}} &= 3.
 \end{aligned}$$

3. Calculate the hydrogen ion concentration of a solution whose  $\text{p}^{\text{H}}$  is 4.45.

$$\begin{aligned}
 \text{p}^{\text{H}} &= 4.45 \\
 \text{p}^{\text{H}} &= -\log_{10} [\text{H}^+] \\
 &= 4.45 = -\log_{10} [\text{H}^+] \\
 \log_{10} [\text{H}^+] &= -4.45 = (-4 - 1) + (-0.45) \\
 &= -5 + 0.55 \\
 [\text{H}^+] &= \text{Antilog of } 0.55 \times 10^{-5} \\
 [\text{H}^+] &= 3.548 \times 10^{-5} \text{ g ions/litre.}
 \end{aligned}$$

4. If the pH of a solution is 5.25, calculate the hydrogen ion concentration of the solution.

$$\begin{aligned}
 \text{p}^{\text{H}} &= 5.25 \\
 \text{p}^{\text{H}} &= -\log_{10} [\text{H}^+] \\
 5.25 &= -\log_{10} [\text{H}^+] \\
 \log [\text{H}^+] &= -5.25 = (-6 + 0.75) \\
 [\text{H}^+] &= \text{antilog } (0.75) \times 10^{-6} \\
 &= 5.623 \times 10^{-6} \text{ g ions/litre.}
 \end{aligned}$$

5. Calculate the  $\text{p}^{\text{H}}$  of 0.1 m NaOH solution.

0.1 m NaOH means

$$\begin{aligned}
 &= 0.1 \text{ g ions/litre.} \\
 \text{p}^{\text{OH}} &= -\log_{10} [\text{OH}^-] \\
 &= -\log_{10} [0.1] \\
 &= -\log_{10} [1 \times 10^{-1}] \\
 &= -[-1] \\
 &= 1. \\
 \text{p}^{\text{H}} + \text{p}^{\text{OH}} &= 14 \\
 \text{p}^{\text{H}} + 1 &= 14 \\
 \text{p}^{\text{H}} &= 14 - 1 = 13
 \end{aligned}$$

## Indicators

An indicator is a substance, which has one colour in acid solution and a different colour in alkaline solution. Indicator is a substance, which indicates the exact completion of a chemical reaction by changing colour at the end point.

Example:

Phenolphthalein, Methyl Orange, Methyl Red

Indicators are used in titrations to determine the end point. During the acid-bass titration, if certain  $p^H$  is reached, indicator changes its colour.

<u>Indicator</u>	<u>Colour Change</u>	<u><math>p^H</math> Range</u>
Phenolphthalein	Colorless to Pink (Acid) (Base)	8 - 9.5
Methyl Orange	Red to Yellow (Acid) (Base)	4.5 – 6.5

It is very clear from a study of the above table that phenolphthalein which becomes colorless when  $p^H = 8$  will indicate that the solutions is acidic. Methyl orange shows a yellow alkali colour when  $p^H = 4.5$  will indicate the solution is acidic. Therefore selection of indicators is more important for acid-bass titrations. It depends upon the nature of acid and the base involved in that titration.

### **BUFFER SOLUTION**

Maintaining of  $p^H$  is more important in many industries. For that buffer solution is needed. Buffer solution is one which maintains a constant  $p^H$  even when small amount of acid or alkali are added to the solution.

Buffer solution is classified into two types.

1. Acidic buffer
2. Basic buffer

Acidic buffer is obtained by mixing a weak acid with a salt of the same weak acid.

#### **Example**

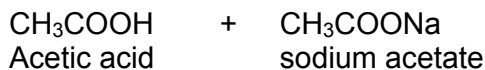

Basic buffer is obtained by mixing a weak base with a salt of the same weak base.

#### **Example**

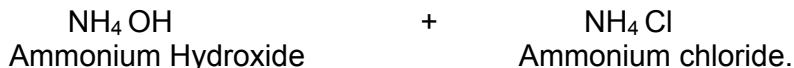

### **INDUSTRIAL APPLICATIONS OF pH**

$p^H$  is more important in many industries to get high yield and the quality.  $p^H$  plays a vital role in the following industries.

1. Textile Industry:  
In textile industry, the  $p^H$  of dye has to be maintained otherwise dyeing will not be uniform and permanent.
2. Sugar Industry:  
The  $p^H$  of the sugarcane juice should be maintained between 8 and 9. Otherwise crystallization of sugar will not be better.

- Leather Industry:  
The  $p^H$  of solution for Tanning purpose should be 2.5 to 3.5. If not, the hides will putrify.
- The  $p^H$  of liquid chlorine is more effective in the  $p^H$  range of 5 to 6.5 in water treatment.
- The  $p^H$  of the soil should be maintained for plants to grow and to get better yield.
- The  $p^H$  of human blood is 7.2. If not, it causes coagulation of blood which leads to death.
- The  $p^H$  of a gastric juice is 1.4 to 2. Otherwise it may cause vomiting and stomach disorder.
- Here are the industries where  $p^H$  plays a vital role: Paper industry, Alcohol industry, Medicine and Chemical industry, Food production industry etc.

## QUESTIONS

### PART-A

- What is  $p^H$ ?
- What is  $p^{OH}$ ?
- What is ionic product of water?
- What is Buffer solution?

### PART-B

- What is an Indicator? Give examples.
- What is Arrhenius theory of acid and base?
- What is Bronsted –Lowry theory of acid and base?
- What is Lewis concept of acid and base?

### PART-C

- Explain the Bronsted-Lowry theory of acids and bases with examples.
- Explain the Lewis concept of acids and bases with examples. Mention its advantages also.
- Write a note on applications of  $P^H$  in industries.

## PROBLEMS

- The hydrogen ion concentration of a solution is  $2 \times 10^{-4}$  g ions/litre. Calculate the  $p^H$  of the solution.
- The hydroxyl ion concentration of a solution is  $1 \times 10^{-9}$  g ion/litre. Calculate the  $P^H$  of the solution.
- The  $p^H$  of a solution is 4.28. Calculate the hydrogen ion concentration of the solution.
- The  $p^H$  of a solution is 11.5. Calculate the hydrogen ion concentration of the solution.

**UNIT-II**  
**SOLUTION, COLLOIDS AND NANO-PARTICLES**

**2.1. SOLUTIONS**

**INTRODUCTION**

In this chapter we are going to study about true solutions and the different modes of expressing the concentrations of chemical solutions. Study of different units used to measure the concentration of solutions is essential, since in various estimations of chemicals in different fields these concentration units are employed.

**Definition:**

Solution is a homogeneous mixture of solute and solvent whose proportion varies within certain limits.

**Solute:**

Solute is the substance present in smaller quantities in a solution.

**Solvent:**

Solvent is the substance present in larger quantities in a solution.

**Methods of expressing concentration of solutions:**

1. Molarity
2. Molality
3. Normality
4. Mole-fraction
5. Percentage by mass

**Mole: n (See First lesson)**

When the molecular mass of the substance expressed in grams it is known as gram molecular mass or one Mole.

$$\text{Number of Moles (n)} = \frac{\text{Mass in grams}}{\text{Molecular Mass}}$$

Mole of the solvent is represented as  $n_1$

The mole of the solute is represented as  $n_2$

Molecular mass of water is 18

Gram molecular mass of water is =18 g or one mole.

One mole of water =18g

Two mole of water is =36 g.

**Molarity (M):**

Molarity is the number of moles of solute present in 1000 ml or one litre of solution. The symbol used to represent molarity is 'M'.

For example a 5.2 M solution of glucose contains 5.2 mole of glucose in every 1000 ml of solution.

The mass given in moles can be converted in to mass in grams provided we know the molar mass of a chemical.

### Molar solution (Molarity =1M)

A Molar solution contains one mole of solute in one litre of solution.

### Formula used to determine the molarity of a given solution

Molarity  $\times$  Molecular mass = Mass of solute present in 1000ml of solution.

Or

$$\text{Molarity } M = \frac{\text{Mass of the solute} \times 1000}{\text{Molecular mass of the solute} \times \text{Volume of the solution}}$$

### Worked out Problems.

1. Calculate the molarity of a solution containing 4 grams of sodium hydroxide (NaOH) in 500 ml of the solution.(Molecular mass of sodium hydroxide=40)

Mass of sodium hydroxide = 4 g

Molecular mass of sodium hydroxide=40 g (23X1+16X1+1X1)

$$\text{Molarity } M = \frac{\text{Mass of the solute} \times 1000}{\text{Molecular mass of the solute} \times \text{Volume of the solution}}$$

$$\text{Molarity } M = \frac{4 \times 1000}{40 \times 500}$$

$$\text{Molarity } M = \frac{8}{40} = 0.2M$$

2. Calculate the molarity of solution containing 40g of sugar (C<sub>12</sub>H<sub>22</sub>O<sub>11</sub>) in 200 ml of solution.(Molecular mass of sugar=342).

### Formula

Molarity  $\times$  Molecular mass = Mass of solute present in 1000ml of solution.

$$\begin{aligned} \text{Molecular mass of sugar} &= 12 \times 12 + 22 \times 1 + 16 \times 11 \\ &= 342 \end{aligned}$$

Mass of sugar

Present in 200ml of solution = 40g

Therefore

Mass of sugar present in 1000ml of solution = 200g

$$\text{Molarity } M = \frac{\text{Mass of the solute} \times 1000}{\text{Molecular mass of the solute} \times \text{Volume of the solution}}$$

Substituting the values in the formula,

$$\text{Molarity } M = \frac{40 \times 1000}{342 \times 200}$$

$$\text{Molarity } M = \frac{200}{342} = 0.5848M$$

Therefore Molarity = 0.5848

3. Find the mass of urea  $\text{CO}(\text{NH}_2)_2$  present in 4 litres of a 0.452M solution. (Molecular mass of urea=60)

Molecular mass of urea =  $12 + 16 + 2 \times 14 + 4 \times 1 = 60$

### **Formula**

Mass of solute present in 1000ml or one litre of solution = Molarity  $\times$  Molecular mass

$$= 0.452M \times 60$$

= 27.12g. Therefore Mass of solute present in 4 litre of solution =  $4 \times 27.12 = 108.48g$ .

### **MOLALITY (M):**

Molality is the number of moles of solute present in 1000g Or 1Kg of the solvent.

Molality is represented by the symbol 'm'.

For example a 2.5 m solution of glucose ( $\text{C}_6\text{H}_{12}\text{O}_6$ ) contains 2.5 moles of glucose in 1000g of water.

### **Molal solution (Molality =1m)**

A Molal solution contains one mole of solute in one Kg of solvent.

Formula used to determine the molality of the solution

$$\text{Molality} \times \text{Molecular mass} = \text{Mass of solute in 1000g of solvent}$$

$$\text{Molality } m = \frac{\text{Mass of solute} \times 1000}{\text{Molecular mass of solute} \times \text{Mass of solvent}}$$

Worked out Example

1. Calculate the molality of a solution containing 4 grams of sodium hydroxide (NaOH) in 500 gms of water. (Molecular mass of sodium hydroxide=40).

Mass of sodium hydroxide = 4 g

Molecular mass of sodium hydroxide=40 g (23X1+16X1+1X1)

$$\text{Molality } m = \frac{\text{Mass of the solute} \times 1000}{\text{Molecular mass of the solute} \times \text{mass of the solvent}}$$

$$\text{Molality } m = \frac{4 \times 1000}{40 \times 500}$$

$$\text{Molality } m = \frac{8}{40} = 0.2m$$

2. Calculate the molality of a solution containing 15g of methanol (CH<sub>3</sub>OH) in 300g of solvent. (Molecular mass of methanol=32)

Molecular mass of methanol = 12 + 16 + 4×1 = 32

Formula:

$$\text{Molality } m = \frac{\text{Mass of solute} \times 1000}{\text{Molecular mass of solute} \times \text{Mass of solvent}}$$

Mass of methanol present in 300g of water = 15g

Therefore

$$\text{Molality } m = \frac{15 \times 1000}{32 \times 300}$$

$$\text{Molality} \times 32 = 50$$

$$\text{Therefore Molality} = 50/32 = 1.5625\text{m}$$

3. Calculate the molality of 5% solution of glucose (molecular mass of glucose=180)

In a solution the percentage of the solute glucose is= 5%

Hence the percentage of the solvent water is = 95%

Therefore

The mass of glucose is=5 g

The mass of water is=95 g

Molecular mass of glucose is=180

$$\text{Molality } m = \frac{\text{Mass of solute} \times 1000}{\text{Molecular mass of solute} \times \text{Mass of solvent}}$$

$$\text{Molality } m = \frac{5 \times 1000}{180 \times 95} = \frac{5000}{17100} = 0.2926 \text{ m}$$

#### **Mole-fraction of solvent( $X_1$ )**

Mole-fraction of the solvent is the ratio between the number of moles of solvent and the total number of moles present in solution. The mole of the solvent is denoted as  $n_1$  and the mole of the solute is  $n_2$ .

$$\text{Mole-fraction of solvent} = \frac{\text{Number of Moles of solvent } (n_1)}{\text{Total number of Moles present in solution } (n_1+n_2)}$$

$$= \frac{n_1}{n_1 + n_2}$$

#### **Mole-fraction of solute( $x_2$ )**

Mole-fraction of the solute is the ratio between the number of moles of solute and the total number of moles present in solution.

$$\text{Mole-fraction of solute} = \frac{\text{Number of Moles of solute}}{\text{Total number of Moles present in solution}}$$



$$\frac{n_2}{n_1 + n_2}$$

(Total number of moles present in the solution = number of moles of solute + number of moles of solvent)

In any solution, **the sum of mole-fraction of solute and solvent is equal to one i.e.  $x_1 + x_2 = 1$ .**

Mass in gram

Note: Number of moles = -----

Molecular Mass

In any solution, the sum of mole-fraction of solute and solvent is equal to one.

To prove that the sum of mole fractions of solute and solvent in a solution is equal to one

Let x and y be the number of moles of solute and solvent respectively

$$\text{Mole-fraction of solute} = \frac{x}{x + y}$$

$$\text{Mole-fraction of solvent} = \frac{y}{x + y}$$

Mole-fraction of solute + Mole-fraction of solvent

$$= \frac{x}{x + y} + \frac{y}{x + y} = \frac{x + y}{x + y} = 1$$

Hence it is proved.

Worked out example

1. Find the number of moles of solute and solvent in a solution containing 9.2g of ethyl alcohol ( $C_2H_5OH$ ) in 180 g of water.

Molecular mass of ethyl alcohol =  $2 \times 12 + 6 \times 1 + 16 = 46$

Molecular mass of water = 18

Number of moles of ethyl alcohol = Mass / Molecular mass

$$= \frac{9.2}{46} = 0.2$$

Number mole of water =  $\frac{180}{18} = 10$

Total number of moles =  $0.2 + 10 = 10.2$

Mole fraction of ethyl alcohol = Number of moles of alcohol/total number of moles

$$= 0.2/10.2 = 0.0196$$

Mole fraction of water = Number of moles of water/total number of moles

$$= 10/10.2 = 0.9804$$

**2. A solution is prepared by dissolving 4 g of sodium hydroxide in 18 g of water. (Molecular mass of water is 18, Sodium hydroxide is 40).**

**Calculate**

**(i) Molality of the solution**

**(ii) Mole fraction of Sodium hydroxide and**

**(iii) Mole fraction of water.(Oct.2014)**

Water is solvent=18g

NaOH is solute=4 g

$$\text{Molality } m = \frac{\text{Mass of solute} \times 1000}{\text{Molecular mass of solute} \times \text{Mass of solvent}}$$

$$\text{Molality } m = \frac{4 \times 1000}{40 \times 18} = \frac{4000}{720} = 5.55 \text{ m}$$

Mole fraction of solvent-water ( $X_1$ )

$$\text{Number of Moles } (n) = \frac{\text{Mass in grams}}{\text{Molecular Mass}}$$

$$\text{Number of Moles of water } (n_1) = \frac{\text{Mass of water in grams}}{\text{Molecular Mass of water}}$$

$$\text{Number of Moles of water } (n_1) = \frac{18}{18} = 1$$

$$\text{Number of Moles of NaOH } (n_2) = \frac{\text{Mass of NaOH in grams}}{\text{Molecular Mass of NaOH}}$$

$$\text{Number of Moles of NaOH } (n_2) = \frac{4}{40} = 0.1$$

$$\text{Mole-fraction of Water}(X_1) = \frac{\text{Number of Moles of solvent } (n_1)}{\text{Total number of Moles present in solution } (n_1+n_2)}$$

$$= \frac{1}{1+0.1} = \frac{1}{1.1} = 0.909$$

$$\text{Mole-fraction of NaOH}(X_2) = \frac{\text{Number of Moles of solute } (n_2)}{\text{Total number of Moles present in solution } (n_1+n_2)}$$

$$= \frac{0.1}{1+0.1} = \frac{0.1}{1.1} = 0.09$$

### Normality (N)

Normality is the number of gram equivalents of solute present in 1000 ml of solution. Normality is represented by the symbol 'N'

For example a 0.5N solution of NaOH contains 0.5 gram equivalents of NaOH dissolved in one litre of solution.

#### Normal solution (Normality – 1N)

A normal solution contains one-gram equivalent of solute present in one litre of solution.

#### Decinormal Solution (Normality = 0.1N)

A decinormal solution contains one tenth of a gram equivalent of solute in one litre of solution.

#### Formula

$$\text{Normality (N)} = \frac{\text{Mass of solute} \times 1000}{\text{Equivalent mass of solute} \times \text{volume of solution}}$$

#### Problem

Calculate the normality of an oxalic acid solution containing 3.2 g of oxalic acid in 2 litres of solution.

Mass of oxalic acid = 3.2 g

Volume of oxalic acid = 2000ml

Equivalent mass of oxalic acid = 63

$$\text{Normality (N)} = \frac{\text{Mass of solute} \times 1000}{\text{Equivalent mass of solute} \times \text{volume of solution}}$$

$$\text{Normality (N)} = \frac{32 \times 1000}{63 \times 2000} = 0.025 \text{ N}$$

Normality  $\times$  Equivalent mass = Mass of solute present in 1000 ml of solution

We can also have another formula derived from the above said relations as,

Molarity  $\times$  Molecular mass = Normality  $\times$  Equivalent mass.

**Percentage by mass:**

It is defined as the number of grams of solute present in 100 grams of solution.

$$\text{Percentage by mass} = \frac{\text{mass of solute in grams}}{\text{mass of solution in grams}} \times 100$$

Eg: 25% of sugar solution means 25 gms of sugar is present in 100 gms of its solutions.

**(i) 5 g of sodium hydroxide is dissolved in 20 g of water. What is the percentage mass of sodium chloride?(Oct 2014)**

$$\text{Percentage by mass} = \frac{\text{mass. of solute in grams}}{\text{Mass of solution in grams}} \times 100$$

$$\text{Percentage by mass} = \frac{5}{25} \times 100 = 20\%$$

(ii) Find out the percentage by mass when 25 g of sugar is dissolved in 75 gms of water.

$$\text{Percentage by mass} = \frac{\text{mass. of solute in grams}}{\text{Mass of solution in grams}} \times 100$$

$$\text{Percentage by mass} = \frac{25}{100} \times 100 = 25\%$$

**E.g.:** A 20% solution of NaOH by weight contains 20 parts by mass of NaOH dissolved in 80 parts by mass of water. Generally this unit is used to prepare solutions of approximate concentration.

### Worked out problems

1. Find the mass of  $\text{KMnO}_4$  present in 250ml of a 0.05N solution. Given that equivalent mass of potassium permanganate is equal to 31.6.

Mass of  $\text{KMnO}_4$  present in 1000 ml of solution = Normality  $\times$  Equivalent mass

$$= 0.05 \times 31.6 = 1.58\text{g}$$

Therefore Mass of  $\text{KMnO}_4$  present in 250ml of solution

$$= 1.58 \times 250/1000 = 0.395\text{g}$$

2. Find the normality of a solution of sulphuric acid whose molarity is equal to 4M.

Formula

**Molarity  $\times$  Molecular mass = Normality  $\times$  Equivalent mass**

Molecular mass of sulphuric acid = 98

Equivalent mass of sulphuric acid = 49

Molarity of the solution = 4M

Substituting the values in the formula,

$$4 \times 98 = \text{Normality} \times 49$$

Therefore Normality =  $4 \times 98 / 49 = 8\text{N}$ .

Note: The equivalent mass of various chemicals are given below.

<b>Chemicals</b>	<b>Equivalent mass</b>
Hydrochloric acid	36.5
Sulphuric acid	49
Oxalic acid	63
Sodium hydroxide	40
Sodium Carbonate	53
Potassium Permanganate	31.6
Ferrous Ammonium Sulphate	392

## SUMMARY

In this lesson, the students have learnt the meaning of percentage by weight, normality, molarity, molality and mole fraction. They also learned to work out the Problems based on the concept.

### Exercise

#### Part – A

1. Define molarity.
2. Define molality
3. Define a molar solution.
4. Define a Molal solution.
5. Define mole fraction of solute
6. Define normality.
7. Define deci-normal solution.

#### **Part-B**

1. Show that the sum of mole fractions of solute and solvent in a solution is equal to one.

#### Part – C

**(Note: To work out the problems in the examination, students should be given chemical formula and atomic weights of the elements present in the given compound to determine the molecular mass of the compound.)**

1. Calculate the weight of potassium hydroxide (KOH) required to prepare 400ml of 0.082 M solution.
2. Find the mass of urea (Molecular mass = 60) required to prepare a decimolar solution of it in 250 ml of solution.
3. Calculate the Molality of a solution containing 5.6 g of potassium hydroxide in 250 g of water.
4. Find the mass of sugar required to prepare m/10 solution of it in 300ml of water.
5. Find the Molality of a solution of 40 g of sodium hydroxide in 450 g of water.
6. 64g of methyl alcohol ( $\text{CH}_3\text{OH}$ ) is dissolved in 144g of water. Calculate the mole-fraction of methanol and water.
7. Find the mole-fraction of both solute and solvent in a solution containing 1.12g of potassium hydroxide in 179.64 g of water.
8. A solution of sodium carbonate contains 1.06 g of  $\text{Na}_2\text{CO}_3$  dissolved in 100 ml of water. Calculate its concentration in normality.
9. Find the mass of oxalic acid present in 500 ml of a decinormal solution of oxalic acid.
10. Find the normality of 0.5M sulphuric acid.
11. Find the molarity of a 2N solution of sulphuric acid.

## 2.2. COLLOIDS

### INTRODUCTION

An aqueous solution of salt or sugar is homogeneous and it contains the solute particles as single molecules or ions. This is called a **true solution**.

In sugar solution, the sugar particles are not visible to the naked eye or under microscope. The diameter of the solute particle is less than  $10^{-7}$  cm.

On the other hand when we mix sand and water, a heterogeneous mixture called coarse suspension is formed. The sand particles are visible because the diameter of the particle is greater than  $10^{-5}$  cm. A heterogeneous mixture of dispersed particle in the dispersion medium falling in the range  $10^{-7}$  to  $10^{-5}$  cm is called as colloid.

The particles, which are larger than a molecule and smaller than a suspended particle, are said to be colloids and such solutions are called colloidal solutions or sols.

Molecular size < colloids < suspension  
 $10^{-7}$  cm             $10^{-7}$  to  $10^{-5}$  cm    (More than  $10^{-5}$  cm)

### Definition

A colloidal system is made up of two phases. The substance distributed as a colloidal particle is called the dispersed phase (analogous to solute) and the phase where the colloidal particles are dispersed is called the dispersion medium (analogous to solvent).

**A heterogeneous mixture of a dispersed phase and dispersion medium is called as 'Colloid'.**

A colloidal solution can form eight different types based upon the physical state (solid, liquid, gas) of dispersed phase and dispersion medium.

The common examples of colloids are milk, curd, cheese, clouds, paint etc.

**Table -Differences between true solution and colloidal solutions**

Sl. No.	Property	True Solution	Colloidal Solution
1.	Nature	Homogeneous system	Heterogeneous system
2.	Size	$1-10\text{\AA}(10^{-7}\text{cm})$	$10\text{\AA}-2000\text{\AA}(10^{-7}\text{to}10^{-5}\text{cm})$
3.	Filtration	Cannot be filtered	can be filtered through animal or starch membrane
4.	Scattering of light	It does not scatter light	It scatters light
5.	Brownian movement	Does not exhibit	Does exhibit
6.	Electrophoresis	Does not show	Does show
7	Coagulation	Cannot be coagulated	Can be coagulated

**The dispersed phase:**

**A substance which is dispersed into particles of colloidal size in a dispersion medium is called the dispersed phase.**

**The dispersion medium:**

**The continuous medium in which the colloidal particles are dispersed is called the dispersion medium.**

For example, in colloidal starch solution, starch is the dispersed phase and water is the dispersion medium.

## **TYPES OF COLLOIDS**

**Based on the affinity** between the dispersion medium and dispersed phase the colloid is classified into two types. They are

### **1. Lyophilic colloids**

Colloidal solutions in which the dispersed phase has more affinity for the dispersion medium are called Lyophilic colloids [Lyo-solvent; philic-attract]. e.g. gelatin, protein, starch. The Lyophilic and Lyophobic colloids have different characteristics.

### **2. Lyophobic colloids**

Colloidal solutions in which the dispersed phase has very little affinity for the dispersion medium are termed as lyophobic colloids [Lyo-solvent; phobic-hate].E.g. colloidal solutions of metals and sulphur in water.

#### **Differences between Lyophilic and Lyophobic colloids**

<b>Sl. No.</b>	<b>Property</b>	<b>Lyophilic colloids</b>	<b>Lyophobic colloids</b>
1.	Preparation	Can be easily prepared	Need some special methods to prepare
2.	Affinity towards solvent	Solvent attracting	Solvent hating
3.	Coagulation	Coagulation requires large quantity of electrolytes	A small quantity of electrolyte is sufficient
4.	Detection through ultra microscope	Cannot be easily detected	Can be easily detected
5.	Viscosity	Very much different from that of dispersion medium	Almost the same as that of dispersion medium
6.	Surface tension	Very much different from that of dispersion medium	Almost the same as that of dispersion medium
7.	Density	Very much different from that of dispersion medium	Almost the same as that of dispersion medium



8.	Electrophoresis	Particles migrate in either direction	Migrate in a particular direction
9.	Reversibility	The reaction is reversible	Irreversible
10.	Example	Starch solution, soap solution.	Colloidal gold, silver.

### Property of colloids

Colloids exhibit certain exclusive properties. They are:

- (i) Mechanical / kinetic property
- (ii) Optical property
- (iii) Electrical property
- (iv) Chemical property

#### (i) Mechanical / kinetic property (Brownian movement)

When the colloidal particles are seen through an ultra microscope, it is found that the colloidal particles are found to be in constant zig-zag, chaotic motion.

**Fig- Brownian movement**

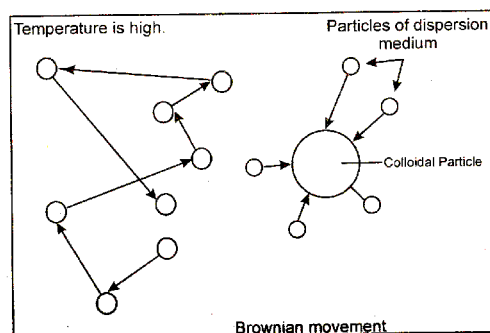

This was first observed by Brown and so **this random movement of colloidal particles is called Brownian movement**. This movement is due to the unequal collisions of colloidal particles with the molecules of the dispersion medium. The motion becomes more rapid when the temperature of the dispersion medium is high and less viscous.

#### Optical property (Tyndall effect)

**Fig.3.2. Tyndall effect**

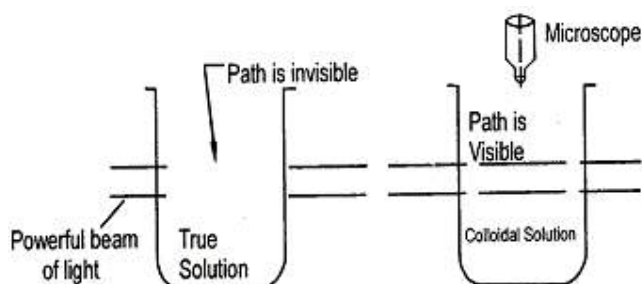

When the beam of light is passed through a true solution and if it is observed at right angles to the direction of the beam, the path of the light is not clear. At the same time, if the beam of light is passed through a colloidal solution, the path of the light is quite distinct due to scattering of light by the colloidal particles. **The phenomenon of scattering of light by the colloidal particles is known as "Tyndall effect".**

### Electrical property (Electrophoresis)

If an electric potential is applied across two platinum electrodes immersed in a colloidal solution, the colloidal particles move in a particular direction, depending upon the charge of the particles.

**Thus the movement of colloidal particles under the influence of electricity is called electrophoresis.**

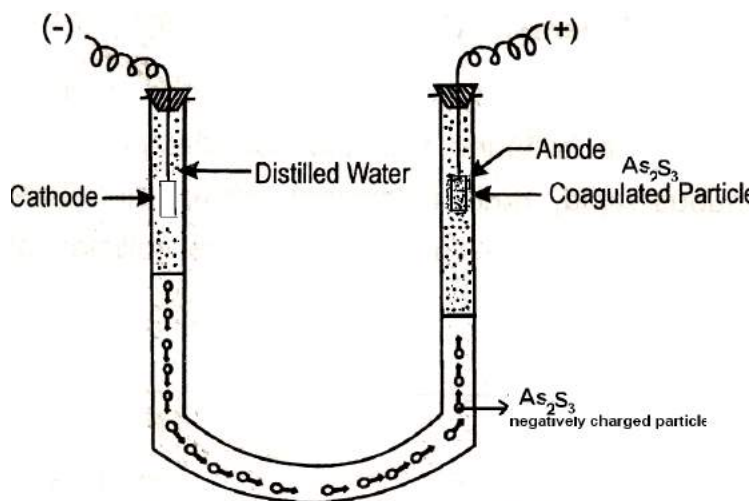

**Fig. Electrophoresis**

This phenomenon can be demonstrated by placing a layer of arsenic sulphide solution under two limbs of a U-tube. When current is passed through the limbs, it can be observed that the level of the colloidal solution drops out at one end of the limb and rises on the other end.

### Coagulation of colloid :( Chemical property)

The entire colloidal particles are electrically charged. The particles are either positively charged or negatively charged. Therefore every colloidal particle repels each other and remains stable. In order to coagulate a colloid, first of all these charges have to be nullified. This can be done in three ways:

- (i) By adding a double salt (electrolyte)
- (ii) By introducing an electrode of opposite charge
- (iii) By introducing another colloid of opposite charge

After neutralizing the charges, the colloidal particles are brought together and they are large enough to settle down. ***Thus the process of precipitating a colloidal solution is called coagulation.***

## **INDUSTRIAL APPLICATIONS OF COLLOIDS**

### **Smoke precipitation**

Smoke is a colloidal suspension of carbon particles in air. The smoke is first introduced into a chamber and subjected to a very high voltage. The particles are deposited in one of the electrodes and the hot air alone is let out through the chimney.

### **Purification of drinking water**

The suspended impurities of the water cannot be filtered. So it is better to coagulate them. This is done by adding potash alum.

### **Cleansing action of soap**

The dirt particles stick to the cloth or body by the greasy oily substance. It forms an emulsion with soap. The dirt particles get detached from the cloth / body and washed away along with soap with excess of water.

### **Tanning of leather**

Animal hides are colloidal in nature. When a hide (positively charged particles) soaked in tannin (negatively charged particle) mutual coagulation takes place. This results in hardening of leather and the process is called tanning. Chromium salts are used as tannin.

### **Disposal of sewage**

Sewage dirt particles are electrically charged. So the sewage is allowed to pass through disposal tanks. It is then subjected to high potential. The sewage particles lose the charges and coagulated. Clean water is recycled or used for gardening. Sludge is used as manure.

**Summary:** In this lessons the students have learnt about the true solution, colloid, types of colloids, difference the properties and application of colloids.

### **QUESTIONS:**

#### **Part-A**

1. What is a colloid?
2. Give any two examples for colloid.
3. What are the two types of colloids?
4. Give any two examples for lyophilic colloid.

#### **PART-B**

1. Define Tyndall effect.
2. What is called Brownian movement?
3. What is meant by electrophoresis?
4. Write notes on Tyndall effect
5. Define coagulation of colloid.

#### **Part-C**

1. Distinguish between true solution and colloidal solution.
2. What are the differences between Lyophilic and Lyophobic colloids?
3. Write down any five applications of colloids.

## 2.3. NANO PARTICLES

### INTRODUCTION

Nano technology is the study of matter on an atomic and molecular scale. One nanometer is one billionth or  $10^{-9}$ m. The carbon-carbon bond length is in the range of 0.12-0.15 nm, the DNA double helix has a diameter of 2nm, and that of bacteria will be around 200nm. **So particles of nanometer size are called Nano particles.**

### DEFINITION

**Nanoparticles are particle that have size ranging from 10to100 nanometer.  $1\text{nm}=10^{-9}\text{m}$ .** These are usually particles at the atomic or molecular size.

### CHARACTERISATION

Materials reduced to nanometer scale show unique characteristics. For instance, opaque substance become transparent (copper), stable materials turn combustible (aluminium), insoluble materials become soluble (gold). Therefore materials on nanoscale find wide applications in the field of medicine, electronics and in all fields of engineering.

### Application of nanoparticle technology in medicine

The biological and medical research communities have exploited the properties of nano particles for various applications:

Integration of nano materials with biology led to the development of diagnostic devices and drug delivery vehicles.

- **Diagnosics:**

Gold nano particles tagged with DNA can be used for the detection of genetic sequence.

Manganese oxide nanoparticles have been used as contrast agent for magnetic resonance imaging (MRI).The results of an MRI scan can be used to help diagnose conditions, plan treatments and assess how effective previous treatment has been.

Nanoparticles are used for early and specific cancer detection and therapy.

- **Drug Delivery:** Drug can be delivered for specific cell using nano particles.

- **Tissue Engineering**

- 1.This may replace today's conventional treatment like organ transplants/artificial implants.
- 2.Advanced forms in tissue engineering may lead to life extension.
- 3.It can repair the targeted damaged tissue.
- 4.Lipid based nanoparticles are used in cosmetics and Creams.
- 5.The zinc oxide nanoparticles block the UV rays, hence it is used in Sunscreen lotion.

### **Application of nanotechnology in electronics**

- (i) Today's solar cells utilize only 40% solar energy. Nanotechnology could help to increase the efficiency of ***light conversion using nanostructures.***
- (ii) The efficiency of internal combustion engine is about 30-40% Nano technology could ***improve combustion by designing catalysts with maximized surface area.***
- (iii) The use of batteries with higher energy content is possible with nano materials.
- (iv) Nanotechnology has already introduced integrated circuits in nanoscale (50nm) in CPU's and DRAM devices.
- (v) Carbon nano-tubes based cross bar memory called Nano-RAM gives high density memory for computers has been developed.
- (vi) The data storage density of hard discs is increased by using the nanoparticle.

### **Biomaterials**

- Problems in Food and bioprocessing industry for manufacturing high quality of safe food can be solved using nanotechnology.
- Bacteria identification and food quality monitoring using biosensors are examples of application of nano technology.
- A nano composite coating act as anti microbial agents.
- Natural bone surface is 100nm across. If the artificial bone implant is smooth, the body rejects it. So nano sized finishing of hip and knee would help the body to accept the implant.

**SUMMARY:** In this lesson the students have learnt about the nanoparticles, importance and applications in various fields.

### **QUESTIONS**

#### **PART-A**

1. What are nanoparticles?
2. Mention few unique characteristics of nanoparticles.

#### **PART-B**

1. Explain the applications of biomaterials.

#### **PART-C**

1. Mention few applications of nanotechnology in engineering.
2. How the nanotechnology becomes useful in the field of medicine?

## UNIT-III

### TECHNOLOGY OF WATER, CATALYSIS, GLASS

#### 3.1 TECHNOLOGY OF WATER

##### INTRODUCTION

Water is the most essential compound for all living matter on the earth. It plays an important role in human living, industrial and agricultural purposes. So there is no life in the earth without water.

##### Sources of water

The two important sources of water are (1) surface water and (2) underground water.

##### Surface water

The water available on the earth's surface is called as surface water. Surface water includes rainwater, river water, lake water and seawater.

##### Underground water

Underground water includes water present between the rocks in the earth crust, spring water, well water etc.

##### Reason for Depletion of underground water

The decrease in the quantum of underground water is depletion of water. Depletion of water is mainly caused by,

1. Modernization, industrialization and population growth
2. Global warming causing excess evaporation of surface water
3. Deforestation
4. Decrease in rainfall caused by seasonal changes and
5. Effluents from the industries spoiling the ground water source.

To meet out this depletion of ground water sources, it is essential to find alternate plans using water management techniques to recharge the ground water sources. One of the techniques adopted is rainwater harvesting.

##### Rain water Harvesting

Rainwater harvesting (RWH) is a technique of capturing and storing of rainwater (tanks, slums, lake) for useful purposes and recharging the excess water into the ground.

The methods employed are

1. Roof top harvesting
2. Open space harvesting

##### Rooftop harvesting

Rainwater is directly used for recharging open wells and bore wells by directing them into it. It can also be stored in sumps or overhead tanks and used directly.

## Open space Harvesting

Open spaces around the buildings are used for rainwater harvesting as follows

1. With percolation/recharge pits
2. Recharge trenches
3. Recharge wells

The recharge method used depends on the soil condition.

## Advantages of rain water harvesting

1. RHW increases the ground water level.
2. It avoids the depletion of underground water.
3. Soil erosion is prevented.
4. It also prevents flooding in urban areas during rainy season.
5. It ensures the availability of water for our future generation.

## Types of impurities present in water

There are three types of impurities present in water. They are

- (i) Suspended and colloidal impurities.
- (ii) Dissolved salts.
- (iii) Microorganisms.

## Types of water

There are two types of water.

They are (i) soft water and (ii) hard water.

- I. **Soft water** readily gives lather with soap.
- II. **Hard water** does not give lather with soap.

## Hardness of water

There are two types of hardness in water. They are:

- (i) Temporary Hardness: **(Carbonate hardness)**

It is due to the presence of calcium bicarbonate  $[\text{Ca}(\text{HCO}_3)_2]$  and magnesium bicarbonate  $[\text{Mg}(\text{HCO}_3)_2]$ .

Temporary Hardness can be removed by boiling.

- (ii) Permanent Hardness: **(Non-Carbonate hardness)**

It is due to the presence of chloride and sulphate salts of calcium and Magnesium. ( $\text{CaCl}_2$ ,  $\text{CaSO}_4$ ,  $\text{MgCl}_2$ ,  $\text{MgSO}_4$ ). Hence it is called as permanent hard water.

## Methods of expressing the Hardness.

The hardness of water can be expressed by any one of the following two methods.

Units for measuring hardness

### 1. mg/litre of CaCO<sub>3</sub>

It is the number of mg CaCO<sub>3</sub> of present in one litre of water or mg/lit

### 2. part per million of CaCO<sub>3</sub>

It is the number of parts by weight of CaCO<sub>3</sub> present in million parts of water or ppm.

1mg / litre = 1 ppm

Usually, the hardness of water is expressed in terms of calcium carbonate equivalents.

The formula used to convert the mass of hardness producing salt to the mass of CaCO<sub>3</sub> equivalent is given below.

$$\left. \begin{array}{l} \text{Calcium} \\ \text{Carbonate} \\ \text{Equivalents} \end{array} \right\} = \frac{\text{Mass of salt} \times \text{Molecular mass of CaCO}_3}{\text{Molecular mass of salt}}$$

### To prove the relation between mg/litre and ppm

Let us consider a water sample whose hardness is 'x' mg/litre of CaCO<sub>3</sub>.

Therefore, Mass of CaCO<sub>3</sub> present in 1000ml of water = Y mg i.e. Mass of CaCO<sub>3</sub> present in 1000g of water =  $Y \times 10^{-3}$ g  
Therefore,

Mass of CaCO<sub>3</sub> present in 10<sup>6</sup>g of water =  $Y \times 10^{-3} \times 10^6$

$$= Y \times 1000g.$$

Hence hardness of water is = Y ppm.

Therefore, 1 mg / litre = 1 ppm. Hence it is proved.

Even though CaCO<sub>3</sub> is not a hardness producing salt and is insoluble in water, it is used as the standard to express the hardness of water. Since the hardness producing salts are present in traces, mass of CaCO<sub>3</sub> equivalent to hardness producing salt is calculated to express the hardness of a water sample.

The formula used to convert the mass of hardness producing salt to mass of CaCO<sub>3</sub> is given as follows.

One molecular mass of Hardness producing salt  $\equiv$  one molecular mass of CaCO<sub>3</sub>

Note: Molecular masses of hardness producing salts are given below.



<u>Hardness producing salt</u>	<u>Molecular Mass</u>
CaSO <sub>4</sub>	136
MgSO <sub>4</sub>	120
CaCl <sub>2</sub>	111
MgCl <sub>2</sub>	95
Ca (HCO <sub>3</sub> ) <sub>2</sub>	162
Mg (HCO <sub>3</sub> ) <sub>2</sub>	146

1. A water sample contains 48 mg of MgSO<sub>4</sub> per 200ml of water. Calculate the hardness in terms of CaCO<sub>3</sub> equivalent in mg/litre of CaCO<sub>3</sub>.

One molecular mass of MgSO<sub>4</sub> = one molecular mass of CaCO<sub>3</sub>

i.e. 120 mass of Mg SO<sub>4</sub> = 100 mass of CaCO<sub>3</sub>

Therefore mass of 48mg of MgSO<sub>4</sub> =  $\frac{48 \times 100}{120}$  = 40mg of CaCO<sub>3</sub>

Mass of CaCO<sub>3</sub> present in 200 ml of water = 40mg

Therefore,

Mass of CaCO<sub>3</sub> present in 1000ml of water = 200mg

Hardness of water = 200mg/litre of CaCO<sub>3</sub>

### **Disadvantages of a hard water sample**

- Hard water cannot be used for drinking, as it does not quench thirst.
- It cannot be used for cooking purposes.
- It cannot be used for bathing and washing purposes as it does not give lather with soap.
- Hard water cannot be used in laboratories as it gives unwanted chemical reactions.
- Hard water cannot be used in boilers in steam raising.
- It cannot be used in sugar and paper industries.
- Hard water cannot be used in textile and leather industries.

### **ESTIMATION OF HARDNESS OF WATER -EDTA METHOD**

EDTA method is used to determine the hardness of a sample of water. EDTA refers to Ethylene-diamine tetra acetic acid. This method is also called Modern method.

## PRINCIPLE:

This is a volumetric method based on the principle of formation of complexes. Ethylene diamine tetra acetic acid (E.D.T.A.) forms colorless complexes with  $\text{Ca}^{2+}$  and  $\text{Mg}^{2+}$  ions present in water. Similarly Eriochrome Black-T, another dye, also forms wine red coloured complexes with  $\text{Ca}^{2+}$  and  $\text{Mg}^{2+}$  ions. Pure Eriochrome Black-T is blue in colour. At the pH range of 9 to 10, the Eriochrome complexes are less stable when compared to E.D.T.A. complexes. Thus when E.D.T.A. solution is added to Eriochrome- $\text{Ca}^{2+}$  or  $\text{Mg}^{2+}$  complexes it displaces pure Eriochrome to form E.D.T.A- $\text{Ca}^{2+}$  or  $\text{Mg}^{2+}$  complexes. Thus at the end point E.D.T.A. frees the total Eriochrome Black-T to change the colour of the solution from wine red to steel blue.



Wine Red

Steel Blue

## PROCEDURE:

The burette is filled with the standard E.D.T.A. solution. A 50-ml pipette is washed with distilled water and rinsed with the sample of hard-water. Exactly 50 ml of hard-water is pipetted out into a conical flask and 5 ml of  $\text{NH}_4\text{Cl} - \text{NH}_4\text{OH}$  buffer solution is added. A pinch of Eriochrome Black-T indicator is added. The colour of the conical flask solution changes into wine red. The water sample is titrated against the E.D.T.A. Solution taken in the burette. The colour changes from wine red to steel blue. This is the end point of the titration. The burette reading is noted. Titrations are repeated until two consecutive values agree. From the volume of E.D.T.A. the hardness of the sample of water is calculated.

**Note:** In the estimation of hardness of water, a standard already established formula is used. This gives a standard data relating the mass of  $\text{CaCO}_3$  and volume of 0.01M EDTA solution. The formula is

$$1\text{ml of } 0.01\text{M EDTA solution} \equiv 1\text{mg of CaCO}_3$$

### HARD WATER Vs EDTA

Sl. No.	Volume of Hard water	Burette Reading		Volume of EDTA (ml)	Indicator
		Initial	Final		
1	20	0			Eriochrome Black-T
2	20	0			
3	20	0			

## CALCULATION:

Let V ml be the volume of E.D.T.A. Hard water.

$$1 \text{ ml of } 0.01 \text{ M E.D.T.A.} \equiv 1 \text{ mg of CaCO}_3$$

Therefore V ml of 0.01 M E.D.T.A. = V mg of  $\text{CaCO}_3$

50 ml of Hard water contains V mg of  $\text{CaCO}_3$

Therefore Weight of CaCO<sub>3</sub> present In 1000 ml of Hard water

$$\begin{aligned} &= \frac{V \times 1000}{50} \text{ mg} \\ &= 20 V \text{ mg} \end{aligned}$$

**HARDNESS OF WATER = 20V mg /litre of CaCO<sub>3</sub>**

(Note: In the estimation of hardness, 0.01M EDTA solution is prepared by dissolving 3.72 g of Disodium salt of EDTA in 1000 ml of distilled water.

NH<sub>3</sub> - NH<sub>4</sub>Cl buffer solution is prepared by dissolving 67.5 g of ammonium chloride (AR) in 200ml of water and by adding 570ml of Liquor ammonia (AR) with specific gravity 0.92 and the total volume is made up to one litre.)

Worked out Example

1. A sample of 100 ml of hard water consumes 25 ml of 0.01M EDTA solution. Calculate the hardness of the sample of water.

Formula

1ml of 0.01M EDTA solution  $\equiv$  1mg of CaCO<sub>3</sub>

Therefore, 25ml of 0.01M EDTA solution  $\equiv$  25 mg of CaCO<sub>3</sub>

By titration, 25ml of 0.01M EDTA solution  $\equiv$  100 ml of hard water

Therefore

Mass of CaCO<sub>3</sub> present in 100 ml of hard water = 25 mg

Therefore

Mass of CaCO<sub>3</sub> present in 1000ml of hard water = 250mg

Hence hardness of water = 250mg/litre of CaCO<sub>3</sub>

To give in ppm

Mass of CaCO<sub>3</sub> present in 100 ml of hard water = 25 mg

Mass of CaCO<sub>3</sub> present in 100g of hard water =  $25 \times 10^{-3}$ g

Therefore

$$\begin{aligned} \text{Mass of CaCO}_3 \text{ present in } 10^6 \text{g of hard water} &= \frac{25 \times 10^{-3} \text{g} \times 10^6}{100} \\ &= 250 \text{g} \end{aligned}$$

Hence hardness of water = 250 ppm of CaCO<sub>3</sub>

2. A sample of 100 ml of water consumed 12.5 ml of 0.01 M EDTA solution. In another titration 100 ml of the same sample, after boiling for half an hour consumed 8.2 ml of the same EDTA solution. Calculate the carbonate and non-carbonate hardness of the sample of water.

(NOTE: In the given problem, volume of EDTA consumed in the first titration is equivalent to total hardness of water which includes both carbonate and

non-carbonate hardness. But the volume of EDTA consumed by the water after boiling is equivalent to non-carbonate hardness as carbonate hardness in water can be removed by boiling water.)

#### Total hardness

1ml of 0.01M EDTA solution  $\equiv$  1mg of  $\text{CaCO}_3$

Therefore,

12.5ml of 0.01M EDTA solution  $\equiv$  12.5 mg of  $\text{CaCO}_3$

By titration,

12.5ml of 0.01M EDTA solution  $\equiv$  100 ml of hard water

Therefore

Mass of  $\text{CaCO}_3$  present in 100 ml of hard water = 12.5 mg

Therefore mass of  $\text{CaCO}_3$  present in 1000ml of Hard water = 125mg

Hence Total hardness of water = 125 mg/litre of  $\text{CaCO}_3$

#### Non-carbonate Hardness

1ml of 0.01M EDTA solution  $\equiv$  1mg of  $\text{CaCO}_3$

Therefore,

8.2ml of 0.01M EDTA solution  $\equiv$  8.2 mg of  $\text{CaCO}_3$

By titration,

8.2ml of 0.01M EDTA solution  $\equiv$  100 ml of hard water

Therefore

Mass of  $\text{CaCO}_3$  present in 100 ml of hard water = 8.2 mg

Therefore

Mass of  $\text{CaCO}_3$  present in 1000ml of hard water = 82 mg

Hence

Non-carbonate hardness of water = 82 mg/litre of  $\text{CaCO}_3$

Therefore

Carbonate Hardness = Total hardness – Non-carbonate hardness  
= (125 – 82) = 43 mg/litre of  $\text{CaCO}_3$

#### **SOFTENING OF HARD WATER**

The method of converting the hard water into soft water is called softening of hard water. Two important methods of softening the hard water are 1. Ion-Exchange method 2.Reverse Osmosis method.

## Ion Exchange method

(Demineralization Method or de-ionization method)

In this method the hard water is first passed through an acidic resin having replaceable hydrogen ion ( $RH_2$ ) to remove the cations [ $Ca^{2+}$ ,  $Mg^{2+}$ ] and then it is passed through a basic resin [ $R'(OH)_2$ ] having replaceable hydroxyl ion to remove the anion. Thus both types of ions are totally removed.

Acid resin is represented by  $RH_2$ .

Base resin is represented by  $R'(OH)_2$ .

### Softening Process:

When the hard water sample is passed through the acid resin, calcium and magnesium ions are removed.



Acidic resin

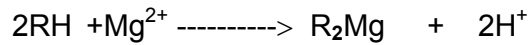

Acidic resin

When this water is passed through the base resin, chloride, bicarbonate and sulphate ions are removed.

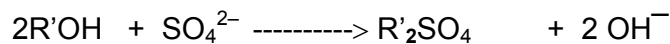
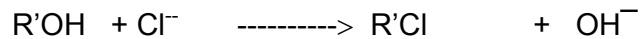

Basic resin

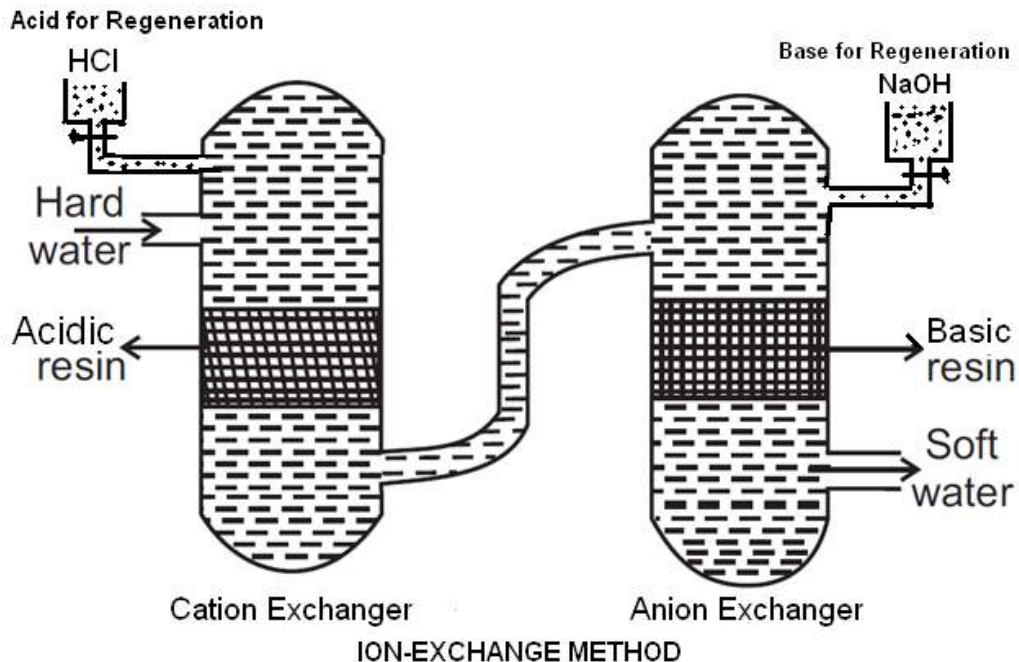

Thus both types of ions are removed from water. The  $H^+$  and  $OH^-$  ions combine together to form water.

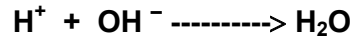

The quality of water obtained by this method is equivalent to distilled water.

### **Regeneration of Acidic Resin and Basic Resin:**

After a long use, the acidic resin can be regenerated by washing it with strong solution of Hydrochloric acid.



The basic resin after a long use can be regenerated by washing it with a strong solution of NaOH.

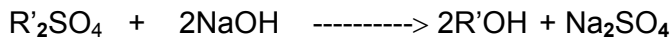
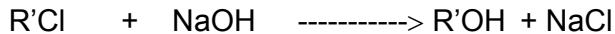

### **Advantages**

- 1) In this method, both types of hardness are removed.
- 2) The quality of water obtained is equivalent to distilled water.
- 3) There is no wastage of water.

## **Reverse Osmosis Method**

### **Osmosis**

When two solutions of different concentrations are separated by a semi-permeable membrane, solvent molecules move from the region of low concentrated side to the region of high concentrated side until the two concentrations become equal. This process is called osmosis. The pressure gradient produced due to osmosis is called osmotic pressure.

### **Reverse Osmosis**

When a hydrostatic pressure greater than the osmotic pressure is applied on the high concentration region, solvent molecules move from high concentration region to the low concentration region across the semi permeable membrane. This is called reverse osmosis. This principle is used in Reverse Osmosis plants to soften hard water.

### **Method**

- ❖ In this method hard water and soft water are taken in two different chambers separated by semi permeable membrane.
- ❖ When a hydrostatic pressure greater than the osmotic pressure is applied on the hard waterside, the water molecules move from hard waterside to soft waterside leaving the impurities on the membrane due to reverse osmosis.

Thus hard water is converted to soft water by Super filtration or hyper filtration

## Diagram

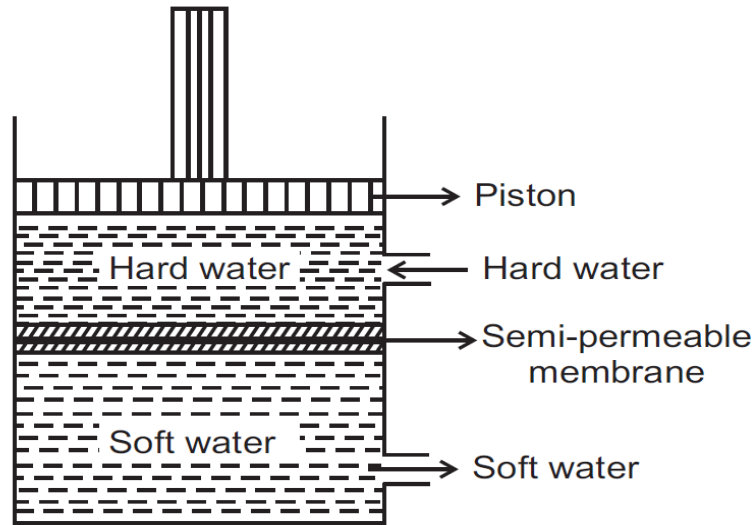

- ❖ The semi permeable membrane is made of polysulphone or cellulose acetate or polyamide.

### Advantages

- 1) In this method ionic, non-ionic, colloidal, and organic particles are removed from water.
- 2) The semipermeable membrane can be replaced and reused.
- 3) There is no wastage of water.

## MUNICIPAL WATER SUPPLY

### WATER FOR DRINKING PURPOSE (Potable water)

Water used for drinking should be

1. Colourless and odourless
2. Free from colloidal and suspended impurities and
3. Free from microorganisms and bacteria.

The three stages involved in purifying a water sample for drinking purpose are

1. SEDIMENTATION
2. FILTRATION
3. STERILISATION

### SEDIMENTATION

Water from river or lake is taken in the big tank called sedimentation tank. Here the insoluble matter settles down at the bottom of the tank as sediments. In this tank, the colloidal impurities are converted into precipitate by adding Alum. The clear water from the top layer is sent to the next tank called Filtration tank.

## FILTRATION TANK

In filtration tank, the suspended impurities and the microorganisms are removed. In all types of filtration, the filter bed used is constructed as follows.

The filter bed consists of a layer of fine sand followed by the layer of coarse sand, which is then followed, by a layer of gravel. There is a drain at the bottom to remove the filtered water. The layer of fine sand acts as the filtering unit and the other two beds support the fine sand layer. Generally filtration is done due to the gravitational force. The filtered water is then taken to the sterilization tank.

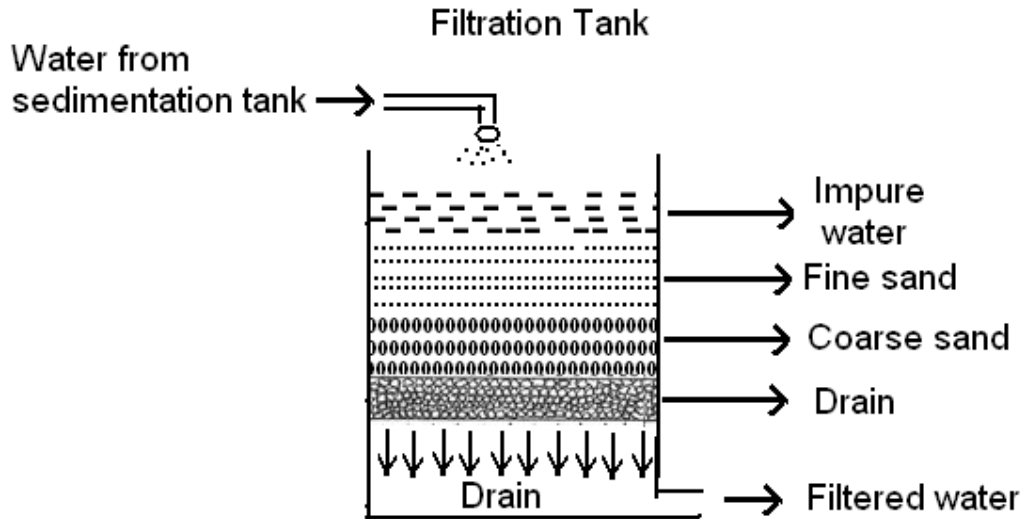

(Note: In drinking water supply schemes, generally gravity filters are used. However, in industrial areas where large amount of drinking water is required in short period, pressure filters are used in which water is sent through filter beds using external pressure. In gravity filtration, there are two types namely slow sand filtration and rapid sand filtration. The difference between these two methods is mainly in the recovery of filter beds used.)

## STERILIZATION

Sterilization is the process of killing the bacteria. It is done by Chlorination.

### Chlorination

Chlorination is addition of chlorine. Chlorine is added to water in the acidic pH range of 6.5 to 7. When chlorine is added to water, it forms HCl and HOCl. The hypochlorous acid molecule enters into the living cells of bacteria and kills them.



Other sterilizing agents used apart from chlorine are chloramines, bleaching powder etc. The advantage of using chloramines is that it does not evaporate out easily and can be carried over to a longer distance along with the water.

Ultra-violet rays can also be used for sterilizing purpose.



## **BOILER FEED WATER**

Water is used in boilers, steam engines etc., to raise steam. When a sample of hard water is used in boiler to prepare steam, the following problems will occur.

1. Scale formation
2. Corrosion of boiler metal
3. Caustic Embrittlement and
4. Priming and foaming.

### **Boiler Scale Formation:**

When hard water is used in boilers to get steam, the impurities that are present in the hard water will settle down on the sides of the boiler. This residue in due course will adhere to the boiler vessel surface in the form of a sludge or scale. This is called as boiler scale. The following calcium salts are responsible for the formation of boiler scale  $\text{CaSO}_4$ ,  $\text{CaCO}_3$ ,  $\text{Ca}(\text{OH})_2$ ,  $\text{Mg}(\text{OH})_2$  etc.

### **Disadvantages of using hard water Boilers**

1. The salt deposit formed is a poor conductor of heat. Therefore fuel is wasted in raising the temperature of the boiler.
2. Due to the increase in the temperature, the plates may melt. This may lead to explosion of boiler.
3. At higher temperature, more oxygen may be absorbed by the boiler metal, which causes corrosion of boiler metal.
4. The sudden spalling of the boiler scale exposes the hot metal suddenly to super-heated steam, which causes corrosion of boiler.

Methods employed to prevent scale formation are,

1. Internal conditioning method
2. External conditioning method.

1. **Internal conditioning methods** involve addition of complexing agents like Calgon to boiler feed water. Another method of internal conditioning is Phosphate conditioning. In this method, sodium phosphate is added to boiler feed water which forms non-sticky Calcium and Magnesium Phosphate Which can be removed by blow down operation.

2. **In External conditioning methods** water is purified either by Zeolite process or by ion-exchange method before being fed into boilers.

### **Corrosion of Boiler metal:**

Water containing the following impurities is responsible for the corrosion of boiler metal. The impurities such as dissolved oxygen, dissolved Carbon dioxide, mineral acids, dissolved salts of calcium and magnesium, organic matter etc. are responsible for the corrosion of the boilers.

The dissolved matter undergoes hydrolysis and forms acids. The acid slowly attacks the inner part of the boiler.

The dissolved oxygen attacks iron at high temperature. The  $\text{CO}_2$  and  $\text{H}_2\text{O}$  form carbonic acid ( $\text{H}_2\text{CO}_3$ ), which slowly attacks the metal.

### **Prevention of Boiler Corrosion:**

1. By using proper water treatment procedures.
2. By degasification to remove the dissolved gases like oxygen, CO<sub>2</sub> etc.,
3. The dissolved CO<sub>2</sub> can be removed by the addition of limewater.
4. Adding calculated amount of base could neutralize the mineral acids.

### **Caustic Embrittlement:**

Sometimes cracks appear inside the boiler parts, particularly at the places, which are under stress. Metal becomes brittle at these places. It is due to the high concentration of caustic soda (NaOH) and a little amount of silica in water. This is called as caustic embrittlement.

Caustic soda is formed by the hydrolysis of Na<sub>2</sub>CO<sub>3</sub>.



Removal of Na<sub>2</sub>CO<sub>3</sub> present in water can prevent caustic embrittlement.

This can be done by the following methods.

1. By adding sulphuric acid.
2. By adding CaSO<sub>4</sub> and CaCl<sub>2</sub> to boiler water
3. By adding Na<sub>2</sub>SO<sub>4</sub>.
4. By adding trisodium phosphate. etc.

### **Foaming and Priming**

#### **Foaming**

Foaming is nothing but the formation of foam. Bubbles of water will enter the surface of water inside the boilers and results in the formation of foam. Foam comes out of the boiler along with the steam. Hence the steam becomes wet and the heat content of the steam is reduced considerably. This type of wet steam spoils the machine parts where it is used.

The main cause for foaming is the presence of dissolved salts in water. Hence soft water should be used in boilers to avoid foaming.

#### **Priming**

Priming is violent and rapid boiling of water inside the boiler. Due to priming, the water particles mix up with the steam when it comes out of the boiler. Like foaming, priming also reduces the heat content of the steam and reduces the efficiency of the steam.

Main reasons for Priming:

- a) Defective design of the boiler.
- b) Presence of large quantities of dissolved salts, oily matter, alkaline and suspended matter.

#### **Control**

1. Priming can be controlled by proper design of the boiler
2. By uniformly heating the water in the boiler.
3. By using a better sample of water.

## Summary

Students have learnt about rain water harvesting, estimation of hardness, methods of softening and bad effects of hard water in boilers.

### QUESTIONS

#### PART – A

1. Define hard and soft waters.
2. List the salts that cause Carbonate and non-carbonate hardness in a water sample.
3. What is rain water harvesting?
4. Mention any two problems caused by using hard water sample.
5. List any two methods of softening of hard water.
6. What is osmosis?
7. What is osmotic pressure?
8. Explain reverse osmosis.
9. Name the membranes used in R.O.method of softening of hard water
10. What is ppm?
11. What is sedimentation?
12. What is sterilization of water?
13. Explain the reaction that takes place when chlorine is added to water.
14. What are boiler scales?
15. What is caustic embrittlement?
16. What is priming?
17. What is foaming?
18. Give any one problem caused by boiler scale.

#### PART – B

1. List the problems caused by hard water?
2. What is rainwater harvesting? What are its goals?

#### PART-C

1. Explain Ion Exchange method of softening a hard water sample.
2. What is regeneration of Ion-exchange plant? How is it carried out?
3. Explain Reverse Osmosis method of softening a hard water sample.
4. Explain EDTA method of estimating hardness of a sample of water.
5. Describe the method used in water supply schemes to get potable water.
6. What are boiler scales? List the problems caused by boiler scale. How to overcome this problem.
7. Explain caustic embrittlement, priming and foaming in boilers during the production of steam.

## 3.2 CATALYSIS

### INTRODUCTION

Catalyst plays an important role in chemical reaction. Catalytic reagents are better than ordinary reagents. Catalyst mainly used to prevent the environmental pollution. It helps us to achieve the goal of green chemistry.

### DEFINITION

A catalyst is a substance which alters the speed of a chemical reaction without itself taking part in the chemical reaction. The process of using a catalyst to alter the speed of a chemical reaction is called as catalysis.

Example,

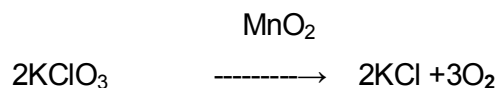

Decomposition of potassium chlorate is very slow under normal conditions. When a small amount of manganese dioxide is added the rate of decomposition of potassium chlorate increases. In the above reaction,  $\text{MnO}_2$  acts as a catalyst. The reaction is called as catalysis.

### TYPES OF CATALYST:

There are two types of catalysts

- (i) Positive catalyst
- (ii) Negative catalyst

#### 1. POSITIVE CATALYST

A catalyst which increases the speed of the reaction is called positive catalyst and the phenomenon is known as positive catalysis. Various examples are given below:

In Decomposition of  $\text{KClO}_3$ ,  $\text{MnO}_2$  will act as a positive catalyst.

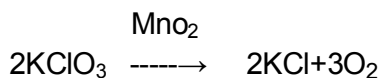

Iron is used as a positive catalyst in the synthesis of ammonia by Haber's process.

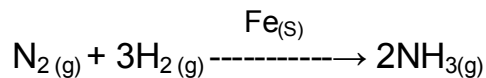

Nitric oxide is used as the catalyst in the lead chamber process

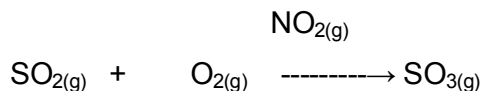

#### 2. NEGATIVE CATALYST:

A catalyst which decreases the speed of the reaction is called negative catalyst and the phenomenon is known as negative catalysis.

The decomposition of hydrogen peroxide is decreases in the presence of glycerin.

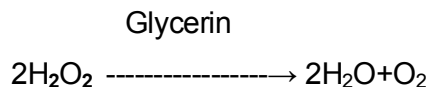

### Promoters:

Promoter is a substance which increases the activity of the catalyst.

The activity of a catalyst can be increased by addition of a small quantity of a second material. These substances which, though itself not a catalyst, promotes the activity of a catalyst is called a promoter.

Some examples of the promoters are given below.

In the Haber's process for the synthesis of ammonia, traces of molybdenum increase the activity of finely divided iron which acts as a catalyst.

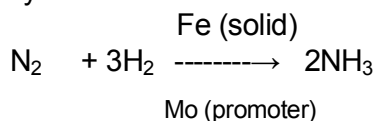

### CATALYTIC POISONS:

Catalytic poison is a substance which lowers the activity of the catalyst.

A substance which destroys the activity of the catalyst is called a poison and the process is called catalytic poisoning. Some of the examples are:

The iron catalyst used in the synthesis of ammonia in Haber process is poisoned by H<sub>2</sub>S.

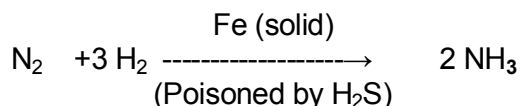

### Types of catalytic reactions

The process of using a catalyst to alter the speed of a chemical reaction is called as catalysis.

Catalytic reactions are classified into two broad types;

1. Homogeneous catalysis
2. Heterogeneous catalysis

### HOMOGENEOUS CATALYSIS:

If the catalyst and the reactants are in the same phase, then it is called as homogenous catalysis.

Example:

In the lead chamber process Oxidation of sulphur dioxide into sulphur trioxide with oxygen in the presence of nitric oxide is used as the catalyst

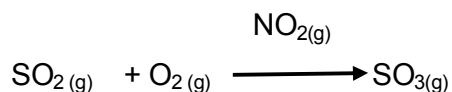

Hydrolysis of methyl acetate is catalyzed by H<sup>+</sup> ions furnished by Hydrochloric acid.

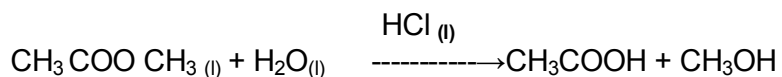

In above two reactions, the catalyst and the reactants are in same phase, hence these reactions are called as homogenous catalysis reactions.

### HETEROGENEOUS CATALYSIS:

If the catalyst and the reactants are in the different phase, then it is called as heterogeneous catalysis. Some of the examples of heterogeneous catalysis are given below.

Iron is used as a positive catalyst in the synthesis of ammonia by Haber's process.

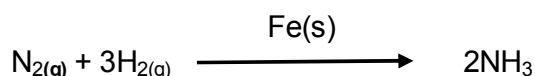

The reactants are in gaseous phase while the catalyst is in solid phase. Hence this reaction is called as heterogeneous catalysis reaction.

#### General characteristics of a catalyst:

The following characteristics are generally common to most of the catalytic reactions.

1. The catalyst remains unchanged in mass and in chemical composition at the end of the reaction. But it may undergo physical change.
2. Only a small quantity of catalyst is generally needed.
3. A catalyst cannot initiate a reaction.
4. The function of a catalyst is only to alter the speed of the reaction which is already occurring at a particular rate.
5. A catalyst does not alter the position of equilibrium in a reversible reaction.
6. The catalyst is generally specific in its action.
7. A catalyst cannot change the nature of the products obtained in a reaction.
8. A catalyst is efficient only at a particular temperature.

#### APPLICATIONS OF CATALYST:

In order to increase the yield of products and also to increase the rate of reaction, catalysts are employed for various applications in industries.

They are

- 1 In the Haber's process for the synthesis of ammonia, traces of molybdenum increase the activity of finely divided iron which acts as a catalyst.

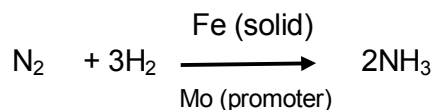

2. In the contact process of preparation of sulphuric acid, platinum is used as a catalyst.

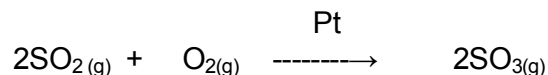

3. In the manufacture of ethyl alcohol from sucrose, the enzyme Invertase and zymase are used as catalyst.

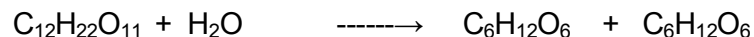

4. In the manufacture of hydrogen chloride from hydrogen and chloride, activated carbon is used as catalyst.

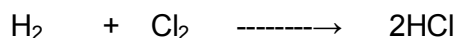

5. In the manufacture of methyl alcohol from CO and H<sub>2</sub>, zinc oxide is used as Catalyst.



6. In the refining of petroleum, phosphoric acid is used as a catalyst.  
 7. In the cracking of petroleum fractions, silica is used as a catalyst.  
 8. In the hydrogenation of vegetable oil, nickel is used as a catalyst.

### Summary

Students learned about the catalyst, catalysis and its application.

### QUESTIONS

#### Part A

1. Define catalyst.
2. Define promoters.
3. What is catalytic poison?
4. Define the term catalysis.
5. Name the types of catalysis.

#### Part B

1. What is a catalyst poison? Explain with example
2. What is a promoter? Explain with example?
3. Explain the heterogeneous catalysis with example

#### PART C

1. Explain any five industrial applications of catalysts
2. What are catalysis reactions? Explain its types with example?
3. Write any five characteristics of a catalyst?

### 3.3-GLASS

#### INTRODUCTION:

Glass is an engineering material. It may be defined as an amorphous, rigid, brittle, hard, transparent super cooled liquid. It is resistant to heat. It is a transparent mixture of silicates of potassium or sodium.

**It is produced by the fusion of certain basic oxides and acidic oxides, with sand and other materials.**

Composition of Glass:

The composition of some common varieties of glass is as follows.

1. Soda lime glass  $\text{Na}_2\text{O} \cdot \text{CaO} \cdot 6\text{SiO}_2$ .
2. Potash lime Glass:  $\text{K}_2\text{O} \cdot \text{CaO} \cdot 6\text{SiO}_2$ .
3. Potash lead glass:  $\text{K}_2\text{O} \cdot \text{PbO} \cdot 6\text{SiO}_2$ .

Raw material required for the manufacture of glass:

The raw materials for the manufacture of ordinary glass are of two kinds.

1. Acidic oxides: sand ( $\text{SiO}_2$ ), Boron oxides ( $\text{B}_2\text{O}_3$ ).
2. Basic oxides: Sodium-oxides ( $\text{Na}_2\text{O}$ ), potassium oxides ( $\text{K}_2\text{O}$ ), calcium oxides ( $\text{Ca}_2\text{O}$ ), Lead Oxide ( $\text{PbO}$ ), Zinc Oxide ( $\text{ZnO}$ ), Magnesium Oxide ( $\text{MgO}$ ) and Aluminum Oxide ( $\text{Al}_2\text{O}_3$ ).

Manufacture of Glass:

Raw materials are:

1. Sand
2. Sodium carbonate
3. Calcium carbonate.

Mixing:

The raw materials are powdered well and they are mixed homogeneously. With this some of the broken glass powders are also added to get an intimate mixture known as "Batch".

Fusion:

The batch is then transferred to the tank or pot furnace. This batch is heated to  $1400-1500^\circ\text{C}$ . At this temperature the substances present in the batch react together forming a mixture of silicates. This mixture of silicates is known as glass.

Fining:

The molten glass is kept at the highest temperature for some time to remove gas bubbles. This is called fining.

$\text{Na}_2\text{CO}_3$  is often added to lower the viscosity of the molten glass. The impurities rise to the top as scum and it is removed. Cullet, oxidizing agents, reducing agents and other materials are also added to the molten glass according to the requirements.



Fabrication:

Coloring material may be added to the molten glass to get desired coloured glass.

Molten glass is then moulded or fabricated into articles of desired shape by blowing, moulding, or pressing.

Colouring Materials

- |                         |         |
|-------------------------|---------|
| 1. Cobalt oxides        | -Blue   |
| 2. Cuprous salt         | -Red    |
| 3. Chromium oxide       | -Green  |
| 4. Ferric iron          | -yellow |
| 5. Potassium dichromate | -Green  |

**Annealing of Glass:**

**The method of slow cooling of glass is called annealing.** If the manufactured hot glass articles are cooled suddenly, it will easily break. To avoid this glass is cooled very slowly by passing them through several hot chambers. The temperature of the hot chamber is in the decreasing order gradually. This process of slow cooling of glass is called as annealing.

The annealing temperature varies for different types of glasses.

**Photo chromatic glass:**

Photo chromic lenses are lenses that darken on exposure to specific types of light, most commonly ultraviolet radiation. Once the light source is removed, the lenses will gradually return to their clear state. Photo chromic lenses may be made of glass, polycarbonate, or another plastic. Traditional photo chromic eyeglasses are generally alkali Boro-alumino -silicates with 0.01 to 0.1 percent silver halide and a small amount of copper. Upon absorption of light, the silver ion reduces to metallic silver, which nucleates to form colloids about 120 angstroms in size. This is small enough to keep the glass transparent, but the colloids are dense enough to make the glass look gray or black.

**Windshield glass**

A framed pane of usually curved glass or other transparent shielding located in front of the occupants of a vehicle to protect them from the wind.

A shield placed to protect an object from the wind.

Modern windshields are generally made of laminated safety glass, a type of treated glass, which consists of two (typically) curved sheets of glass with a plastic layer laminated between them for safety, and are bonded into the window frame. Motorbike windshields are often made of high-impact acrylic plastic.

Laminated glass is produced by permanently bonding two pieces of glass together with a tough Glass plastic interlayer (polyvinyl butyral, PVB) under heat and pressure. Once bonded together, the glass and which acts as a single unit and generally appears very similar to standard clear glass. The inter layer is virtually invisible when viewed in transmission with glass on either side.

**The benefit of laminated glass is that if broken, glass fragments will adhere to the PVB interlayer rather than falling free, thereby**

**reducing the risk of physical injury and property damage.** PVB also has properties that effectively filter over 99% of UV. It also reduces transmission of sound. Hence the windshield glass in cars is a safety device just like seatbelts & airbags. Laminated glass is commonly used in automobiles (for windshields), airports, museums, sound studios, schools, greenhouses.

Windshields protect the vehicle's occupants from wind and flying debris such as dust, insects, and rocks, and provide an aerodynamically formed window towards the front.

**Optical glass: (Crown glass)**

Optical glass is a type of optical glass used in lenses and other optical components. It has relatively low refractive index ( $\approx 1.52$ ) and low dispersion. Crown glass is produced from alkali-lime (RCH) silicates containing approximately 10% potassium oxide and is one of the earliest low dispersion glasses.

**Summary:**

Students have learnt about glass, manufacture of glass and types of glasses.

**QUESTION:**

**PART A**

1. Define glass.
2. What is glass transition temperature?
3. What is optical glass?

**PART B**

1. Write a note on windshield glass
2. Write a note on photo chromatic glass.
3. When windshield glass of a bus/car broken due to accident, it shatters into harmless fragments. How?
4. Today windshield in cars is a safety device just like seatbelts & airbags. How?

**PART C**

1. How is ordinary glass manufactured?
2. What is annealing of glass? Why is it necessary?
3. Write any three varieties of glass

## UNIT-IV

### ELECTROCHEMISTRY, ELECTROCHEMICAL CELL AND ENERGY RESOURCES

#### 4.1 ELECTROCHEMISTRY

##### INTRODUCTION

**Electrochemistry is a branch of chemistry which deals with the relationship between electrical energy and chemical energy. It deals the chemical reactions brought by electric current and chemical reaction producing electrical current.**

Electrochemical reactions find applications in many industries. Electrochemistry broadly discusses about electrical effects on passing electricity through a solution.

Electrolysis comes under this category and finds applications in

- i) Metallurgy
- ii) Electroplating
- lii) Chemical manufacturing processes including medicines.

##### **Chemical effects producing electricity**

Electrochemical cells including Dry cells, Daniel cells, Leclanche cells, rechargeable batteries are used in day to day life in torchlight, transistors, wall clocks, automobiles and cell phones.

The basics of electrolysis and its applications in electroplating are discussed in the following sections.

##### **Electrolyte**

An electrolyte is a substance, which conducts electricity both in solution and in fused state.

Example: Sodium chloride, hydrochloric acid, copper sulphate solution, etc.

##### **Non-electrolytes**

A non-electrolyte is a substance which does not conduct electricity either in solution or in fused state.

Example: Sugar solution, urea solution, alcohol, etc.

##### **Strong electrolytes**

The electrolytes, which ionize completely in solution, are called strong electrolytes.

Example: Sodium hydroxide, potassium chloride, sodium chloride solutions etc.

##### **Weak electrolytes**

Electrolytes which do not ionize completely in solution are called weak electrolytes. Example: Acetic acid, oxalic acid, etc.

## Electrolysis

Decomposition of an electrolyte by passing electric current is called electrolysis. During electrolysis, electrical energy is converted into chemical energy.

Example: Electrolysis of hydrochloric acid.

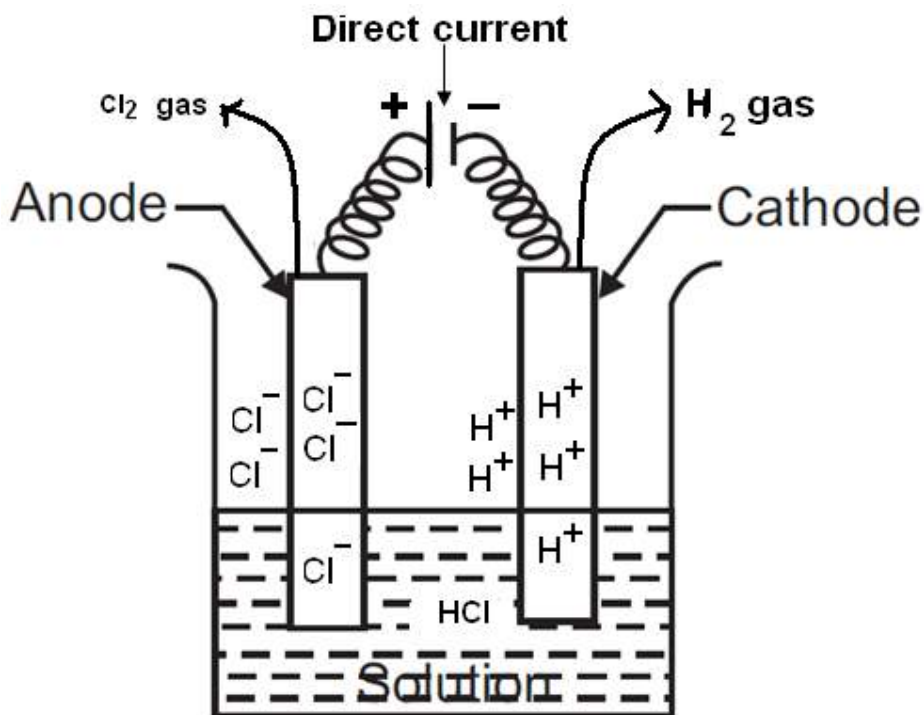

### Mechanism of electrolysis

Hydrochloric acid contains H<sup>+</sup> ions and Cl<sup>-</sup> ions. During electrolysis, H<sup>+</sup> ions move towards the cathode (-ve electrode). So, H<sup>+</sup> ions are called cations. Similarly Cl<sup>-</sup> ions move towards the anode (+ve electrode). So, Cl<sup>-</sup> ions are called anions.

#### Anodic reaction:

At the anode, Cl<sup>-</sup> ions get oxidized to chlorine atoms by loss of electrons.

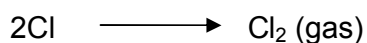

Chlorine gas is liberated at the anode.

#### Cathodic reaction:

At the cathode, H<sup>+</sup> ions get reduced to hydrogen atoms by gain of electrons.

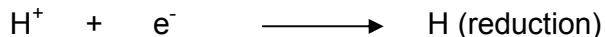

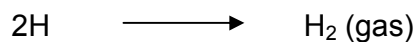

Hydrogen gas is liberated at the cathode.

Thus, hydrochloric acid decomposes into hydrogen and chlorine.

Electrolysis depends on the following factors:

(i) Nature of electrodes used and (ii) Physical nature of electrolytes used.

### **Industrial Applications of Electrolysis**

Electrolysis is applied in

- (i) Electroplating
- (ii) Anodization of Aluminium
- (iii) Electrolytic refining of metals.

### **Electroplating**

**Electroplating is the coating of a more noble metal over a less noble metal by electrolysis.**

Electroplating is done for the following purpose.

- (a) To make the surface corrosion resistant.
- (b) To improve the surface appearance.

In electroplating,

The metal which is to be electroplated (base metal) is taken as cathode; the metal to be coated on (coat metal) is taken as anode. A salt solution of coat metal is taken as electrolyte.

Example: Chrome plating, silver plating, copper plating, gold plating etc.

### **Preparation of surface**

It is essential to clean the article thoroughly before applying a coating. The cleaning of the article is called as 'preparation of surface'.

First, a surface is buffed with emery sheet to get a polished (cleaned) surface.

- The surface is then washed with solvents like acetone to remove oil and grease.
- It is then washed with trisodium phosphate (TSP) to remove any oil and dirt.
- It is finally dipped in 3N hydrochloric acid for few minutes to remove any oxide impurities.
- In between the above operations, the article is washed with water.
- Finally it is washed thoroughly with demineralised water.

### **Factors affecting the stability of the coating**

The nature, stability and thickness of the coating depend on the following factors:

1. Nature of the electrolyte.
2. Nature of the electrode.
3. Solubility of the electrolyte.
4. Concentration of the electrolyte.
5. Temperature.
6. Voltage applied (low).
7. Current density (high).
8. Time for which the current is passed.
9. P<sup>H</sup> of the electrolytic solution.

### Chrome plating

**Coating of chromium over nickel or copper coated mild steel is called chrome plating.**

#### Process:

The nickel or copper coated iron article (base metal) is placed at the cathode.

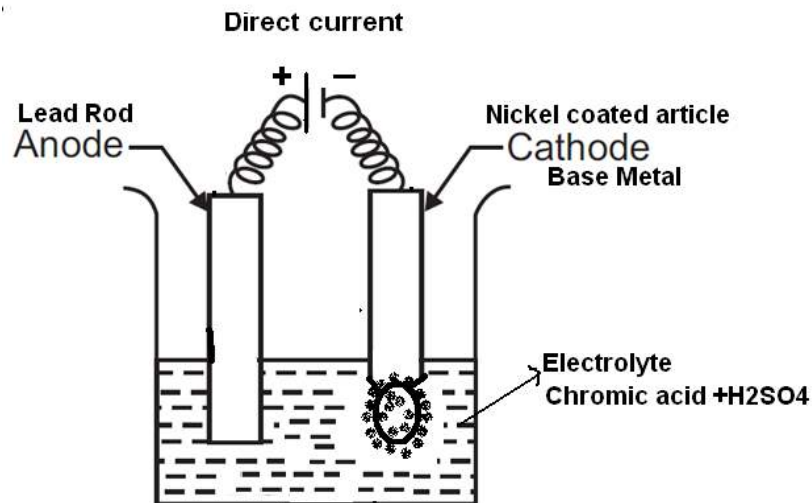

A lead-antimony rod is used as the anode.

A solution of chromic acid and sulphuric acid (100:1) is used as the electrolyte.

Temperature of the electrolytic solution is maintained at 40<sup>0</sup>C to 50<sup>0</sup>C.

A current density of 100 – 200 mA/cm<sup>2</sup> is used.

Sulphate ions act as catalyst for coating.

When electric current is passed, electrolysis takes place and chromium is deposited over the base metal.

A schematic diagram of coating of chromium is given above.

## Electroless plating

**Electroless plating is a technique of depositing a noble metal (from its salt solution) on a catalytically active surface of a less noble metal by employing a suitable reducing agent and without using electrical energy.**

The reducing agent causes reduction of metallic ions to metal which gets plated over the catalytically activated surfaces giving a uniform thin coating.

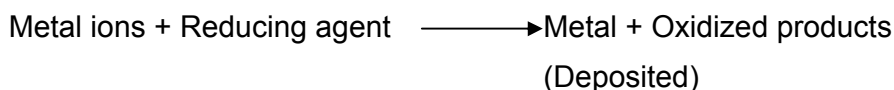

Example: Electroless nickel plating.

### Electroless Nickel plating

#### Procedure:

The pretreated object (example: Stainless steel) is immersed in the plating bath containing  $\text{NiCl}_2$  and a reducing agent, sodium hypophosphite for the required time. During the process, Ni gets coated over the object.

#### Anodic reaction:



#### Cathodic reaction:

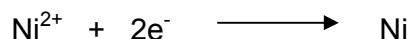

### Advantages of Electroless plating over electroplating

1. No electricity is required for Electroless plating.
2. Electroless plating on insulators (like plastics, glass) and semiconductors can be easily carried out.
3. Complicated parts can also be plated uniformly in this method.
4. Electroless coatings possess good mechanical, chemical and magnetic properties.

### Applications of Electroless plating

1. Electroless nickel plating is extensively used in electronic appliances.
2. Electroless nickel plating is used in domestic and in automotive fields.
3. Electroless nickel coated polymers are used in decorative and functional applications.
4. Electroless copper and nickel coated plastic cabinets are used in digital as well as electronic instruments.
5. Electroless copper plating is used in the manufacture of double sided and multilayered printed circuit boards (PCB).

## Summary

In this lesson, types of electrolytes, mechanism of electrolysis, industrial applications of electrolysis, preparation of surface, factors affecting coating, electroplating, electroless plating, its advantages and applications are discussed.

### QUESTIONS

#### PART - A

1. What is an electrolyte?
2. Give two examples for strong electrolytes.
3. Give two examples for weak electrolytes.
4. Define strong electrolyte.
5. Define weak electrolyte.
6. Define electrolysis.
7. What is chrome plating?
8. What is electroplating?
9. What is Electroless plating?

#### PART – B

1. Give any three industrial applications of electrolysis.
2. Mention any three factors affecting the stability of coating.
3. What is the anode and electrolyte used in chrome plating?
4. Give any three advantages of Electroless plating over electroplating.
5. Give any three applications of Electroless plating.

#### PART - C

1. Explain electrolysis with a suitable example.
2. What are the steps involved in preparation of surface?
3. What are the factors affecting the stability of coating?
4. Explain electroplating with an example.
5. Describe chrome plating with a neat diagram.
6. Explain Electroless plating with an example.



## 4.2. ELECTROCHEMICAL CELL

### INTRODUCTION

A system in which two electrodes are in contact with an electrolyte is called as cell. There are two types of cells,

- i) Electrolytic Cell
- ii) Electrochemical cell.

Electrolytic cell is a device which produces chemical change when an electrical energy from outside source is supplied. Here, electrical energy is converted into chemical energy.

### Electrochemical Cell

**Electrochemical cell is a device in which chemical energy from a redox reaction is utilized to get electrical energy. Here, chemical energy is converted into electrical energy.**

Example: Daniel cell.

### Galvanic Cell

Galvanic cells are electrochemical cells in which the electrons transferred due to redox reaction, are converted into electrical energy. A galvanic cell consists of two half cells with each half-cell contains an electrode. The electrode at which oxidation takes place is called anode and the electrode at which reduction occurs is called cathode. The electrons liberated to the electrolyte from the anode leaves the metal ions at anode. The electrons from the solution are accepted by metal ions at the cathode to become metal.

### Representation of cell:

Galvanic cell is generally represented as follows.

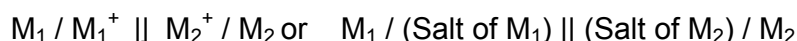

Where,  $M_1$  &  $M_2$  are Anode and Cathode respectively and  $M_1^+$  &  $M_2^+$  are the metal ions in respective electrolyte. The symbol  $\parallel$  denotes salt bridge. The above representation of galvanic cell is known as galvanic cell diagram.

Example: The typical example for galvanic cell is Daniel cell.

### Single electrode potential

**The measure of tendency of a metallic electrode to lose or gain electrons when in contact with a solution of its own salt in a half cell of an electrochemical cell is called as single electrode potential.**

The tendency of an electrode to lose electrons is called oxidation potential while the tendency of an electrode to gain electrons is called reduction potential.

### Formation of Daniel Cell

This cell consists of a zinc rod as anode dipped in zinc sulphate solution (electrolyte) in a glass tank and copper rod as cathode dipped in

copper sulphate (electrolyte) in another glass tank. Each electrode is known as half cell. The two half cells are interconnected by a salt bridge and zinc and copper electrodes are connected by a wire through voltmeter. The salt bridge contains saturated solution of KCl in agar-agar gel. The cell diagram of Daniel cell is

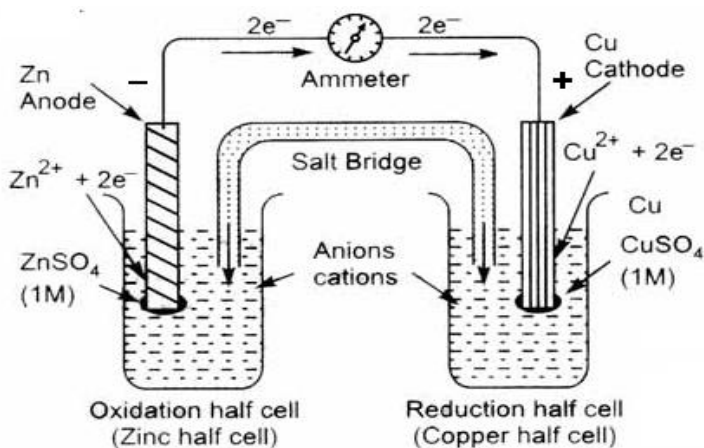
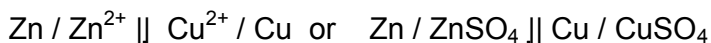

**Daniell cell**

**The other simple diagram of Daniel cell**

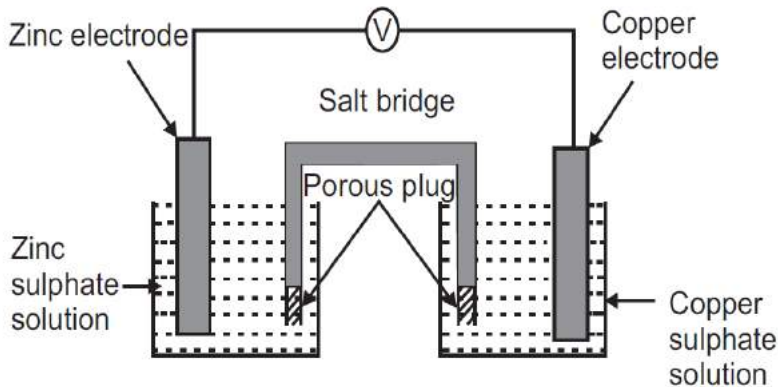

Redox reaction occurs at the electrodes of the Daniel cell:

At anode

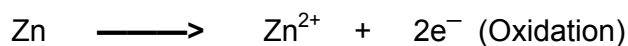

At cathode



Overall Cell reaction



## Electrochemical series

When various metals as electrodes are arranged in the order of their increasing values of standard reduction potential on the hydrogen scale, then the arrangement is called electrochemical series.

## Electrochemical series

Electrode	Electrode Reaction	Reduction Potential ( $E^0$ ) Volts	Nature
$\text{Li}^+ / \text{Li}$	$\text{Li}^+ + \text{e}^- \rightarrow \text{Li}$	-3.01	Anode
$\text{Mg}^{2+} / \text{Mg}$	$\text{Mg}^{2+} + 2\text{e}^- \rightarrow \text{Mg}$	-2.37	Anode
$\text{Pb}^{2+} / \text{Pb}$	$\text{Pb}^{2+} + 2\text{e}^- \rightarrow \text{Pb}$	-1.12	Anode
$\text{Zn}^{2+} / \text{Zn}$	$\text{Zn}^{2+} + 2\text{e}^- \rightarrow \text{Zn}$	-0.76	Anode
$\text{Fe}^{2+} / \text{Fe}$	$\text{Fe}^{2+} + 2\text{e}^- \rightarrow \text{Fe}$	-0.44	Anode
$\text{Sn}^{2+} / \text{Sn}$	$\text{Sn}^{2+} + 2\text{e}^- \rightarrow \text{Sn}$	-0.13	Anode
$\text{H}^+ / \text{H}$	$\text{H}^+ + \text{e}^- \rightarrow \text{H}$	0.00	Pt – reference
$\text{Cu}^{2+} / \text{Cu}$	$\text{Cu}^{2+} + 2\text{e}^- \rightarrow \text{Cu}$	+0.34	Cathode
$\text{Ag}^+ / \text{Ag}$	$\text{Ag}^+ + \text{e}^- \rightarrow \text{Ag}$	+0.80	Cathode
$\text{Au}^+ / \text{Au}$	$\text{Au}^+ + \text{e}^- \rightarrow \text{Au}$	+1.50	Cathode

## Significance and applications of electrochemical series

### i. Calculation of standard EMF of a cell

Standard electrode potential of any cell can be calculated using this series.

### ii. Relative ease of oxidation and reduction

Higher the value of standard reduction potential (+ve value) greater is the tendency to get reduced. Thus, metals on the top having more negative

(-ve) values are more easily ionized (oxidized).

### iii. Displacement of one element by other

Metals which lie higher in the series can displace those elements which lie below them in the series.

### iv. Determination of equilibrium constant for the reaction

The equilibrium constant for the cell can be calculated from the standard electrode potential.

### v. Hydrogen displacement behaviour

Metals having more negative potential in the series will displace hydrogen from acid solutions.

### vi. Predicting spontaneity of redox reactions

Spontaneity of redox reaction can be predicted from the standard electrode potential values of complete cell reaction.

### **Electrolytic Concentration cell**

**The cell in which the current is produced by the transfer of a substance from the solution of higher concentration to the solution of lower concentration is called concentration cell.**

This is also an electrochemical cell. The difference in concentration may be brought about by the difference in concentration of the electrodes or electrolytes.

The concentration cells are classified into two types.

- i) Electrode concentration cell
- ii) Electrolytic concentration cell.

#### **Electrode concentration cell:**

Two identical electrodes of different concentrations are dipped in the same electrolytic solution in a cell is called electrode concentration cell.

Example: Amalgam concentration cells.

Amalgam electrodes are produced by mixing various proportions of lead and mercury. It is represented as,

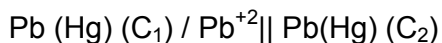

Where,  $C_1$  &  $C_2$  are concentrations of the electrodes.

#### **Electrolytic concentration cell:**

**If two identical electrodes of same concentrations are dipped in the electrolytic solutions of different concentration in a cell, then it is called electrolytic concentration cell.**

Example: Zinc ion concentration cell



- i. A concentration cell is made up of two half cells. Both the half-cell have the same electrodes and the same electrolytes but with different concentration of electrolytes.
- ii. In one half cells Zn is placed in its **low concentrated** solutions.
- iii. In another half-cell the zinc is placed in its **high concentrated** solution.
- iv. They are connected by a salt bridge.

The diagram of an electrolytic concentration cell is

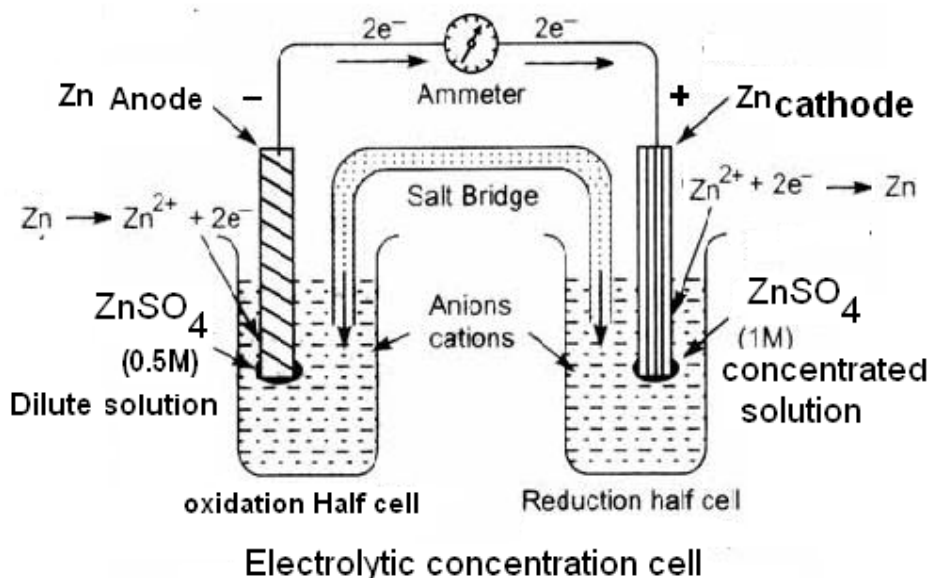

v. **Reaction at anode(Dilute solution)**

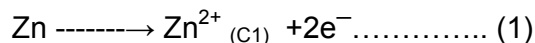

The electrons released move to the other electrode.

vi. **Reaction at cathode(concentrated solution)**

The electrons are taken up by the  $\text{Zn}^{2+}$  (high conc.)

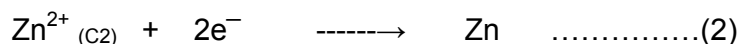

The sum of (1) and (2) gives the net reaction.

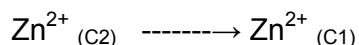

This shows that there is no chemical reaction. So the e.m.f developed is only due to the transfer to  $\text{Zn}^{2+}$  ions from solution of higher concentrations to lower concentrations. The electrolytes of different concentrations try to reach equilibrium by exchange of ions through porous layer. Electrons flow from the anode to cathode producing current when they are externally connected through wire. Hence this cell is called concentration cell.

**Summary**

In this lesson, electrochemical cells, single electrode potential, galvanic cell, construction and working of Daniel cell, significance and applications of electrochemical series and two types of concentration cells are discussed.

## QUESTIONS

### PART – A

1. What is an electrochemical cell?
2. Give two examples for electrochemical cell.
3. Define single electrode potential.
4. What is galvanic cell?
5. Write an example for a galvanic cell.
6. What is Daniel cell?

### PART-B

1. How will you write a short representation of a Daniel cell?
2. Define electrochemical series.
3. Write any three applications of electrochemical series.
4. Define concentration cell.
5. What are the types of concentration cells? Give examples.
6. Give an example for electrode concentration cell.
7. Give an example for electrolyte concentration cell.

### PART - C

1. Explain electrochemical cell with example.
2. Explain the construction and working of Daniel cell.
3. Describe the galvanic cell with cell reactions.
4. What are the applications of electrochemical series?
5. Explain the construction and working of a concentration cell with example.

## 4.3. ENERGY RESOURCES

### INTRODUCTION:

Battery is a device that stores chemical energy and releases it as electrical energy. Hence a device which converts chemical energy into electrical energy is called battery, cell, or storage battery.

A battery is an electrochemical cell which is often connected in series in electrical devices as a source of direct electric current at a constant voltage.

A cell contains one anode and one cathode. The emf of a single cell is around 2 volt. A battery contains several anode and cathode. The emf of a battery which contains six anodes and six cathodes is around 12 v.

### Definition:

**Battery is a device that stores chemical energy and releases it as electrical energy. Hence a device which converts chemical energy into electrical energy is called battery or cell.**

Batteries are classified as follows,

- i) Primary battery
- ii) Secondary battery
- lii) Fuel battery or Flow battery

### Primary battery

Primary battery is a cell in which the cell reaction is not reversible. Thus, once the chemical reaction takes place to release the electrical energy, the cell gets exhausted. They are use and throw type.

Example: Dry cell, Leclanche cell etc.

### Secondary battery

Secondary battery is a cell in which the cell reaction is reversible. They are rechargeable cells. Once the battery gets exhausted, it can be recharged.

Example: Nickel-Cadmium cell, Lead-acid cell (storage cell), etc.

### Dry Cell

A cell without fluid component is called as dry cell.

Example: Daniel cell, alkaline battery.

### Construction and working of Dry cell:

The anode of the cell is zinc container containing an electrolyte consisting of  $\text{NH}_4\text{Cl}$ ,  $\text{ZnCl}_2$  and  $\text{MnO}_2$  to which starch is added to make it thick paste-like so that is less likely to leak. A graphite rod, serves as the cathode, is immersed in the electrolyte in the centre of the cell.

The electrode reactions are given below.

### Anodic reaction

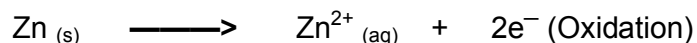

### Cathodic reaction

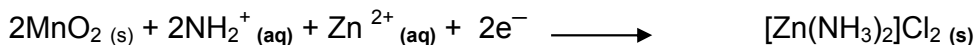
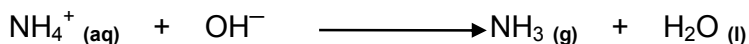
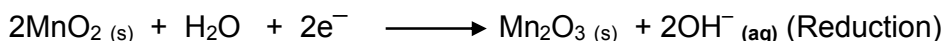

### Overall reaction

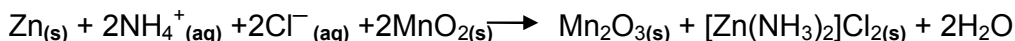

The dry cell is a primary battery, since no reaction is reversible by supplying electricity. Dry cell is very cheap to make. It gives voltage of about 1.5V.

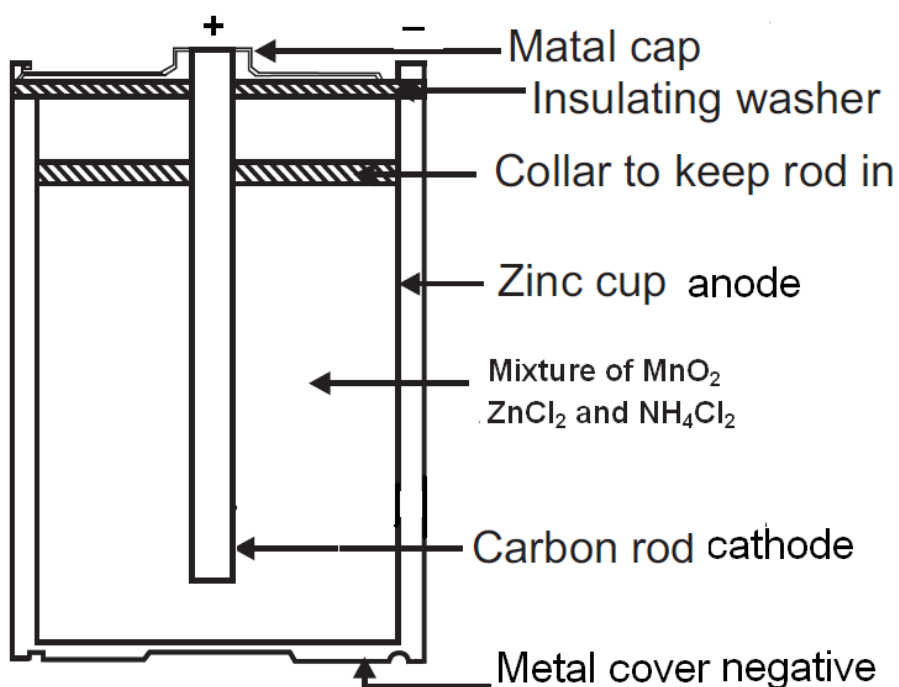

But, it has few demerits: i) When current is drawn rapidly, drop in voltage occurs. ii) Since the electrolyte is acidic, Zn dissolves slowly even if it is not in use.

### Uses

Dry cells are used in flash-lights, transistor radios, calculators, clocks etc.

### **Secondary battery**

Secondary battery is a cell in which the cell reaction is reversible. They are rechargeable cells. Once the battery gets exhausted, it can be recharged.

Example: Nickel-Cadmium cell, Lead-acid cell (storage cell), etc



## Lead – acid storage cell

The typical example for storage cell is Lead-acid storage cell. A secondary battery can operate as a voltaic cell and as an electrolytic cell. When it acts as a voltaic cell, it supplies electrical energy and becomes run down. When it is recharged, the cell operates as an electrochemical cell.

### Construction and Working:

A lead – acid storage cell consists of a number of voltaic cells (3 to 6) connected in series to get 6 to 12 V battery. In each cell, a number of Pb plates, used as anodes are connected in parallel and a number of PbO<sub>2</sub> plates, used as cathodes are connected in parallel. The plates are separated by insulators like rubber or glass fibre. The entire combination is immersed in 20% dil.H<sub>2</sub>SO<sub>4</sub>.

The cell is represented as

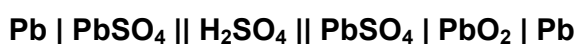

When the lead-acid storage battery operates, the following cell reactions occur.

### Anodic reaction:

Oxidation reaction takes place at anode. The electrons are released from anode. Hence the anode is called as negative anode and is represented as (-).

Lead is oxidized to Pb<sup>2+</sup> ions and gives two electron, which further combines with SO<sub>4</sub><sup>2-</sup> to form insoluble PbSO<sub>4</sub>.

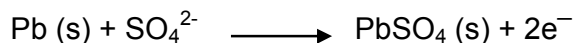

### Cathodic reaction:

Reduction takes place at cathode. Hence the cathode is called as positive cathode and is represented as (+).

PbO<sub>2</sub> is reduced to Pb<sup>2+</sup> ions, which further combines with SO<sub>4</sub><sup>2-</sup> to form insoluble PbSO<sub>4</sub>.

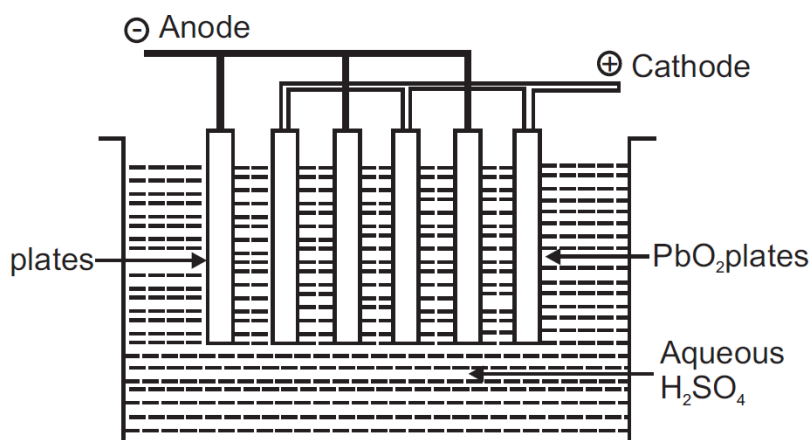
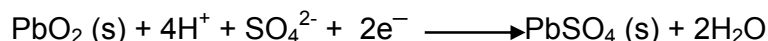

Overall cell reaction during discharging:

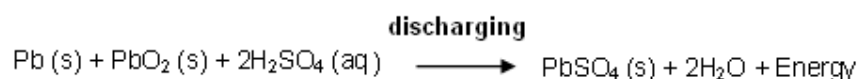

From the above cell reactions, it is clear that  $\text{PbSO}_4$  is precipitated at both the electrodes and the concentration of  $\text{H}_2\text{SO}_4$  decreases. So, the battery needs recharging.

Overall cell reaction during recharging:

The cell can be recharged by passing electric current in the opposite direction. The electrode reaction gets reversed. As a result, Pb is deposited on anode and  $\text{PbO}_2$  on the cathode. The concentration of  $\text{H}_2\text{SO}_4$  also increases.

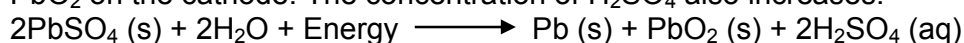

Advantages of Lead – acid batteries:

1. It is made easily.
2. It produces very high current.
3. The self discharging rate is low.
4. It works effectively even at low temperatures.

Uses:

1. Lead – acid batteries are used in cars, buses, trucks etc.
2. It is used in gas engine ignition, telephone exchanges, power stations hospitals.
3. IT industry, educational institutions, laboratories etc.

### **Non-conventional Energy Sources**

Energy received from the sun is the best example for non-conventional energy resources.

Example: Solar cell

#### **Solar cell**

A device which converts the solar energy (energy obtained from the sun) directly into electrical energy is called 'Solar cell'. This is also called as 'Photovoltaic cell'.

Principle:

The basic principle involved in the solar cells is based on the photovoltaic (PV) effect. When sun rays fall on the two layers of semiconductor devices, potential difference between the two layers is produced. This potential difference causes flow of electrons and thus produces electricity.

Example: Silicon solar cell

### Construction:

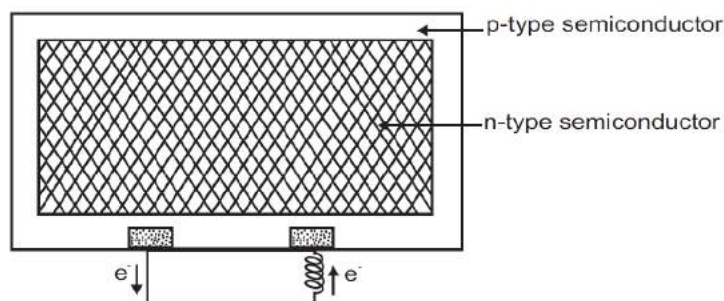

Solar cell consists of a p-type (such as Si doped with boron) and a n-type (such as Si doped with phosphorous) semiconductor plates. They are in close contact with each other.

### Working:

When the solar rays fall on the top layer of p-type semiconductor, the electrons from the valence band get promoted to the conduction band and cross the p-n junction into n-type semiconductor. Thereby potential difference between two layers is created, which causes flow of electrons (i.e. electric current). The potential difference and hence current increases as more solar rays falls on the surface of the top layer.

Thus, when this p- and n- layers are connected to an external circuit, electrons flow from n-layer to p-layer and hence current is generated.

### Applications of solar cells:

1. Solar cells are used in street lights.
2. Water pumps are operated by using solar batteries.
3. They are used in calculators, watches, radios and TVs.
4. They are used for eco-friendly driving vehicles.
5. Silicon Solar cells are used as power source in space crafts and satellites.
6. Solar cells can even be used in remote places and in forests to get electrical energy without affecting the atmosphere.

### **Summary**

In this lesson, various types of batteries, construction, working with cell reactions of storage batteries like, dry cell, lead - acid cell, solar cell and their uses are discussed.

## QUESTIONS

### PART - A

1. Define a storage battery.
2. What is a primary battery? Give example.
3. What is a secondary battery? Give example.
4. Define a fuel cell.

### PART-B

1. What is dry cell? Give an example.
2. Write short representation of lead - acid storage cell.
3. Give any three use of lead – acid battery.
4. What is a solar cell?
5. Give any three applications of solar cells.

### PART - C

1. Explain construction and working of dry cell with example.
2. Explain the construction and working of lead – acid battery.
3. Write a note on solar cell.
4. Explain the uses of solar cells.

## UNIT-V

### CORROSION, METHODS OF PREVENTION OF CORROSION, ORGANIC COATINGS

#### 5.1 CORROSION

##### INTRODUCTION

Corrosion is a 'billion' dollar thief'. Even though it is a natural phenomenon in which the gases, moisture and other chemicals present in the atmosphere react chemically with metals to convert them into their salts, it results in loss of material and money. We know very well that metals have a strong crystalline structure and when they are converted into their salts they lose the metallic strength resulting in the damage to machineries in which they are used. Thus corrosion causes damage to metals and thereby to the society. The estimate of loss due to corrosion is approximately 2.5 billion dollars per annum all over the world. Hence it is necessary to understand the mechanism of corrosion.

In this lesson we are going to study about the causes and the mechanism of corrosion so that we can find ways to prevent this social enemy.

Corrosion is defined as the slow and continuous destruction of metal or alloy by the environment.

Due to corrosion the useful properties of a metal like malleability, ductility, electrical conductivity and also the surface appearance are lost.

The most familiar example of corrosion is rusting of iron when exposed to atmospheric conditions.

Another example is the formation of green film or basic Carbonate [ $\text{CuCO}_3 + \text{Cu}(\text{OH})_2$ ] on the surface of copper when exposed to moist air containing  $\text{CO}_2$  and oxygen.

##### Definition

**Corrosion is defined as the slow and continuous destruction of metal or alloy due to the chemical or electrochemical reaction with its environment.**

It may be due to chemical or electrochemical reaction of the metals with the environment.

**Example: Rusting of iron.**

##### Causes of corrosion:

Metal occur in nature in two different forms. They are

1. Native state
2. Combined state.

## 1. Native state:

The metals occur in native, free, uncombined states or **pure metal are highly stable and non-reactive with the environment**. They do not combine with other elements. They are noble metals exist as such in the earth crust. They have very good corrosion resistance.

Ex. Au, Pt, Ag, Pd, Cu etc,

## 2. Combined state

Except noble metal, all other metals are reactive and form stable compounds as their oxides, sulphides, chloride and carbonates. They exist in the form of stable compounds called ores or mineral.

Ex.  $\text{FeO}_2$ ,  $\text{ZnO}$ ,  $\text{PbS}$ ,  $\text{CaCO}_3$  etc.,

Except noble metal, the other metals in the pure state are thermodynamically **unstable** as they are considered in excited state i.e., higher energy state. Therefore, as soon as the metals are extracted from their ores, the reverse process begins and form stable **metallic compounds**, which are thermodynamically stable, i.e., lower energy state.

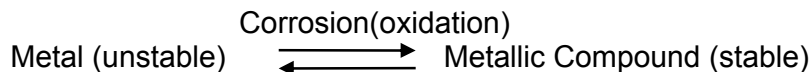

Higher energy state      Metallurgy(Reduction)      lower energy state  
The properties such as electrical conductivity, ductility, malleability etc., are lost due to corrosion.

## Types of Corrosion:

Corrosion is of two types.

1. Chemical Corrosion or Dry Corrosion
2. Electrochemical Corrosion or Wet Corrosion

### 1. Chemical Corrosion or Dry Corrosion

The direct chemical action of atmospheric gases like oxygen, halogens,  $\text{H}_2\text{S}$  etc., in a dry environment on metals is known as chemical Corrosion. Due to this, a dry layer of the Corrosion product is formed on the surface of the metal.

Example:

When magnesium is exposed to atmosphere, magnesium oxide is formed over the surface.

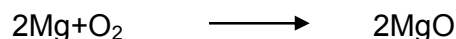

A solid film of the corrosion product is formed on the surface of the metal which protects the metal from further corrosion. If a soluble or volatile corrosion product is formed, then the metal is exposed to further attack.

For example, chlorine attack silver generating a protective film of silver halide on the surface which prevents the further corrosion.

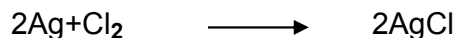

On the other hand, stannic chloride formed on tin is volatile and so corrosion is not prevented.

## 2. Electro Chemical Corrosion or wet corrosion

### Wet corrosion

Wet corrosion occurs due to the electrochemical action of moisture and oxygen on metals. Corrosion of iron takes place due to electrochemical attack.

**There are two theories to explain the rusting of iron.**

1. Galvanic cell formation theory
2. Differential aeration theory.

### 1. Galvanic cell formation theory

#### Definition

“When a metal with impurities (or two dissimilar metals (Fe and Cu) are in contact with each other) is exposed to atmosphere in presence of an electrolyte or moisture, a mini galvanic cell is formed. The more anodic metal undergoes corrosion. This type of corrosion is known as galvanic corrosion”.

#### Example: Rusting of iron

Corrosion is an oxidation process. Oxidation is a process which involves loss of electron. Oxidation takes place at **anode**.

When iron metal with small amount impurities (Cu) is placed in the environment is exposed to the environment (moisture), it undergoes corrosion. Hence it acts as anode and under goes Oxidation. Iron metal loses its two electrons and becomes  $\text{Fe}^{+2}$  ion. Hence the iron metal undergoes oxidation when it is corroded.

The impurities present in the metal act as **cathode** and undergo reduction. The electron released at anode is absorbed at cathode to form either Hydrogen or water or hydroxide ion depending on the environment. The moisture in the environment behaves like **electrolyte**. **Hence a galvanic cell is formed.**

Rusting of iron is explained as below.

#### Anodic reaction (oxidation)

The metal at the anode is oxidised into ferrous ions.

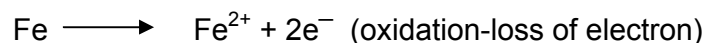

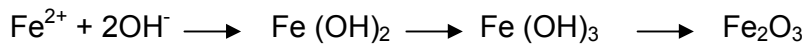

$\text{Fe}^{2+}$  ions combine with  $\text{OH}^-$  in the environment forming ferrous hydroxide  $\text{Fe}(\text{OH})_2$ , which undergoes further oxidation to give ferric hydroxide  $\text{Fe}(\text{OH})_3$ . The ferric hydroxide undergoes decomposition to give ferric oxide  $\text{Fe}_2\text{O}_3$  (Rust).

Thus rust formed is explained based on the theory of Galvanic cell formation.

### **Electrolyte**

The moisture ( $\text{H}_2\text{O}$ ) in the environment acts as an electrolyte. It dissociates to give  $\text{H}^+$  and  $\text{OH}^-$  ions.



### **Cathodic reaction (Reduction)**

The electrons released at anode are taken up by the  $\text{H}^+$  ion in the environment.

(i) In acidic medium (reduction-gain of electron)

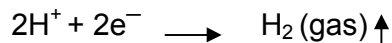

(ii) In neutral solution with oxygen

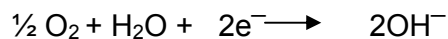

The ferric oxide formed ( $\text{Fe}_2\text{O}_3$ ) over iron is called as Rusting of iron.

Examples:

1. Corrosion of soldered metal around copper wire.
2. Corrosion of steel shaft in bronze bearing.
3. Corrosion of steel pipe connected to copper plumbing.

### **Control**

Galvanic corrosion can be avoided by selecting two dissimilar metals which are very close in the electrochemical series.

It can also be avoided by connecting two dissimilar metals through insulating material.

By making cathodic area smaller and anodic area larger.



### Differential aeration theory or concentration cell formation theory

According to this theory, when a metal is exposed to varying concentrations of air (oxygen) or an electrolyte, concentration cell is formed. The metallic area which is exposed to less amount of oxygen act as anode undergoes corrosion.

The metallic area which is exposed to greater amount of oxygen act as cathode. Corrosion of metal occurs due to difference in concentration of air or electrolyte. **Hence this theory is called as Differential aeration theory or concentration cell formation theory.**

#### **Example:**

##### 1. Corrosion on wire fence

In an iron fence the point where wires cross is less exposed to oxygen and becomes anode. Therefore corrosion takes place at the point of contact where the wire crosses.

2. Metal partially immersed in water, the immersed portion is less exposed to oxygen and becomes anode. Therefore corrosion takes place.

3. Metal area covered by drop of water, sand or dust.

The less oxygenated area acts as Anode (gets corroded)  
The more oxygenated area acts as the Cathode (Protected from Corrosion).  
Reaction At anode- (less oxygenated area)-oxidation-loss of electron- corrosion takes place.

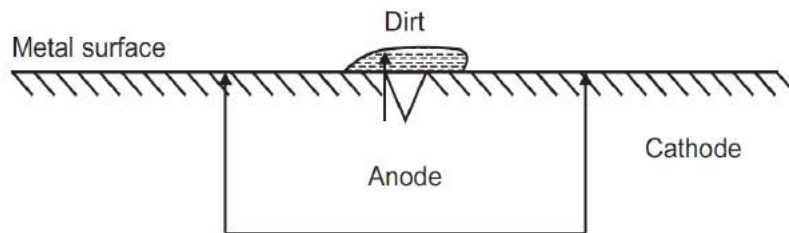
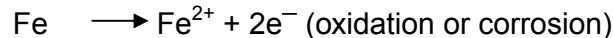

At cathode (more oxygenated area)

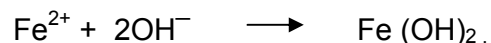
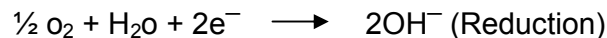

Which is further oxidized to  $\text{Fe}(\text{OH})_3$ . Since the anodic area is small and the cathodic area is large, corrosion is more concentrated at the anode. Thus, a small hole is formed on the surface of the metal. This type of intense localized corrosion is called pitting.

### **Factors influencing the rate of corrosion:**

The factors that affect the rate of corrosion are

- 1) Nature of the metal and its surface
- 2) Nature of the atmosphere
- 3) Nature of the corrosion product.

### **Factors connected with the metal:**

#### **1) The position of the metal in the Electrochemical Series**

The type of impurity present in it and its electropositive nature decides the corrosion of a metal. For example, when iron has impurities like copper, tin, etc. iron corrodes since iron is more electropositive than metals like copper and tin. On the other hand when iron is coupled with zinc, zinc corrodes since zinc is more electropositive than iron.

#### **2) Purity of the metal.**

Generally pure metal does not corrode, as there is no cathode spot available to induce corrosion.

#### **3) Surface of the metal.**

A rough surface corrodes readily as it collects more dirt and provides more cathode spot for corrosion. A polished surface does not corrode easily.

#### **4) Stress corrosion.**

Stress in a metal surface is produced by mechanical workings such as quenching, pressing, bending, and riveting improper heat treatment etc. The portion subjected to more stress acts as anode and other portion act as cathode. This leads to the formation of stress corrosion. Stress corrosion is noted in fabricated articles of certain alloys like high zinc brasses and nickel brasses. Caustic embrittlement noted in boilers is a typical example for stress corrosion, which is due the attack of alkali present in water on stressed boiler metal.

#### **5) Anode to cathode area ratio.**

When a bigger cathode area covers a smaller anode area, severe corrosion is noted in the anodes pot. This is called erosion. It is frequently encountered in piping agitators, condenser tubes etc. where turbulent flow of gases and vapors remove the coated surfaces resulting in differential cells. Removal of surface coatings can also be caused by rubbing or striking activities of solids on the coated surfaces.

#### **6) Physical state of a metal.**

The rate of corrosion is influenced by grain size, orientation of crystals, stress etc. The smaller the grains size of the metal greater the rate of corrosion.

### **Factors connected with the Nature of the atmosphere**

1. Temperature of the atmosphere:  
The rate corrosion increases with increase of temperature.
2. PH of the atmosphere :  
Lower the P<sup>H</sup> greater is the corrosion.
3. Amount of moisture in the atmosphere:  
Increase of moisture in the environment increases the rate of corrosion.
4. Amount of oxygen in the atmosphere:  
In some cases oxygen enhance the corrosion and in another it passivates the metal.
5. Amount of chemical fumes in the atmosphere:  
:Industrial fumes like HCl,H<sub>2</sub>SO<sub>4</sub> produces electrolytes which are acidic in nature and increases the rate of corrosion.

### **Examples**

1. Buried pipelines and cables passing from one type of soil to another suffer corrosion due to differential aeration.
2. Lead pipe line passing through clay get corroded because it is less aerated than sand.

### **Factors connected with the corrosion product**

In some cases the corroded product sticks to the surface and absorbs more moisture. This induces further corrosion. Examples:

- a).In Rusting of iron, as rust formed over iron absorbs more moisture, rate of rusting of iron increases.
- b).In some cases the corroded product acts as the protective coating which prevents further corrosion.
- c). Aluminium oxide formed over the surface of aluminium prevents further corrosion and act as a protective coating. This is the basic principle of Anodization.
- d).In some other cases the corroded product falls out of position exposing the fresh metal surface for further corrosion.

E.g. Magnesium Oxide formed over the surface of Magnesium falls out of position exposing a fresh surface for further corrosion

### **SUMMARY**

In this lesson various types of corrosion, theories explaining corrosion and factors influencing corrosion are explained.

### **Questions:**

#### **Part A**

1. What is corrosion?
2. What is dry corrosion?
3. What is wet Corrosion?
4. What type of corrosion takes place in a metal when anode is small and cathode is large? Why.

#### **Part B**

1. Write a note on galvanic cell formation theory.
2. Write a note on differential aeration theory.
3. What are the factors influencing the rate of corrosion?

#### **PART-C**

1. Explain the mechanism of Galvanic corrosion.
2. Explain the differential aeration theory with suitable examples.

### **TEST YOUR UNDERSTANDING**

1. Why corrosion often takes place under metal washers.
2. Welded joints are better than riveted joints. Why?

## 5.2 METHODS OF PREVENTION OF CORROSION

### INTRODUCTION

Corrosion can be prevented by the following methods:

1. Control of environment
2. Alloying
3. Surface coating
4. Cathodic protection

#### **Control of environment:**

The corrosion rate can be reduced by modifying the environment. The environment can be modified by the following:

1. Deaeration: **Removal of dissolved oxygen and other gases in water by mechanical agitation is called deaeration.** The presence of increased amounts of oxygen is harmful since it increases the corrosion rate. Deaeration aims at the removal of dissolved oxygen. Dissolved oxygen can be removed by deaeration or by adding some chemical substance like  $\text{Na}_2\text{SO}_3$ .
2. Dehumidification: **Removal of moisture content present in air is called as dehumidification.** This can be achieved by adding silica gel which can absorb moisture preferentially on its surface.
3. Inhibitors: In this method, some chemical substance known as inhibitors are added to the corrosive environment in small quantities. These inhibitors substantially reduce the rate of corrosion.

#### **Alloying:**

Both corrosion resistance and strength of many metals can be improved by alloying. eg. Stainless steels containing chromium produce a coherent oxide film which protects the steel from further attack.

#### **Surface Coating:**

**Surface coating the method of coating of one metal over the other metal (metal to be protected from corrosion).** Corrosion of metal surfaces is a common phenomenon. To protect a metal surface from corrosion, the contact between the metal and the corrosive environment (air, moisture, corrosive gases, etc.) is to be cut off. This is done by coating the surface of the metal with a continuous, non-porous material. Such a coating is referred to as surface coating or protective coating. In addition to protective action, such coatings also give a decorative effect and reduces wear and tear.

#### **Objectives of Coating Surfaces**

1. To prevent corrosion
2. To enhance wear and scratch resistance
3. To increase hardness
4. To insulate electrically
5. To insulate thermally

6. To impart decorative colour.

**Metallic Coating:**

Surfacing coatings made up of metals are known as metallic coatings. These coatings separate the base metal from the corrosive environment and also function as an effective barrier for the protection of base metals.

The metal which is coated upon is known as the base metal.

The metal applied as coating is referred to as coat metal.

The different methods used for metal coating are.

1. Hot dipping

(a) Galvanization

(b) Tinning

2. Metal spraying.

3. Cladding.

4. Cementation

(a) Sheardizing – Cementation with Zinc powder is called Shearding.

(b) Chromizing - Cementation with 55% Chromium powder & 45% Alumina is called Chromizing.

(c) Calorizing – Cementiaion with Aluminium and Alumina powder is called Calorizing

5. Electroplating or electrodeposition.

**Hot dipping.**

In the process of hot dipping, the metal to be coated is dipped in the molten bath of the coating metal. Such hot dip coatings are generally non-uniform. The common examples of hot dip coatings are galvanizing and tinning.

1. **Galvanization:** The process of coating a layer of zinc over iron is called galvanization. The steel article is first pickled with dilute sulphuric acid to remove traces of rust, dust, etc. at 60-90<sup>0</sup>C for about 15 -20 minutes. Then this metal is dipped in a molten zinc bath maintained at 430<sup>0</sup>C.

When zinc is coated over iron, zinc and iron forms a galvanic cell. The electropositive zinc forms the anode and undergoes corrosion. Hence iron is protected from corrosion by sacrificial protection method.

The surface of the bath is covered with ammonium chloride flux to prevent oxide formation on the surface of molten zinc. The coated base metal is then passed through rollers to correct the thickness of the film.

It is used to protect roofing sheets, wires, pipes, tanks, nails, screws, etc.

## 2. Tinning:

**The coating of tin over iron is called tin plating or tinning.**

Tinning is done to protect iron, steel and copper from corrosion. It is also called tinning. Since tin is non-toxic, it is mainly used in food industry for coating food containers. Tin-coated utensils are used for storing foodstuffs, pickles, oils, etc.

Tin is nobler metal (more cathodic) than iron. It is more resistant to atmospheric corrosion. Thus, uniform layer of tin protects iron from corrosion.

Tinning the base metal is first pickled with dilute sulphuric acid to remove surface impurities. Then it is passed through molten tin covered with zinc chloride flux. The tin coated article is passed through a series of rollers immersed in a palm oil bath to remove the excess tin. Galvanizing is preferred to tinning because tin is Cathodic to iron, whereas zinc is anodic to iron. So, if the protective layer of the tin coating has any cracks, iron will corrode. If the protective layer of the zinc coating has any cracks, iron being Cathodic and is not corroded. The corrosion products fill up the cracks, thus preventing corrosion.

### **Differences between Galvanizing and Tinning.**

Galvanizing	Tinning
1. A process of covering iron or steel with a thin coat of 'Zinc' to prevent it from rusting.	A process of covering iron or steel with a thin coat of 'Tin' to prevent it from corrosion.
2. Zinc protects the iron sacrificially. (Zinc undergo corrosion)	Tin protects the base metal without undergo any corrosion (non sacrificially)
3. Zinc continuously protects the base metal even if broken at some places.	If any break, in coating causes rapid corrosion of base metal.
4. Galvanized containers cannot be used for storing acidic food stuffs as Zinc becomes toxic in acidic medium.	Tin is non-toxic in nature of any medium.

### **Electroplating (Refer Electrochemistry)**

Electroplating is process in which the coat metal is deposited on the base metal by passing a direct current through an electrolytic solution by means of electrolysis.

#### **Objectives of Electroplating:**

1. To increase corrosion resistance.
2. To get better appearance.
3. To increase the hardness.
4. To change the surface properties of metals and non metals.

## Process

In electroplating, the cleaned base metal is made as the cathode and the coat metal is taken as the anode. A solution of the coat metal salt is taken as the electrolyte. The electrodes are connected to the battery and DC current is passed. Now electrolysis takes place and the coat metal is deposited over the base metal.

The nature of coating depends on 1) the current density 2) time 3) temperature and 4) the concentration of the electrolyte.

For example, to electroplate a spoon made of copper with silver, the copper spoon is taken as the cathode. A silver plate is taken as the anode. Silver thiocyanate solution is the electrolyte. When the electrodes are connected to a DC source of electricity, silver is deposited over the copper spoon.

## Electroplating Diagram

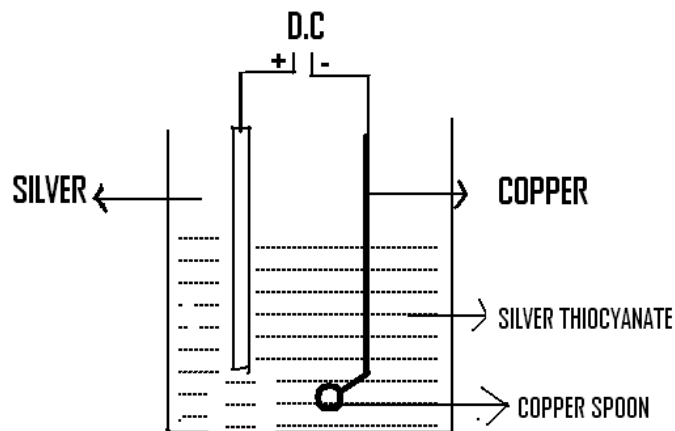

The following electrolytes are used for coating other metals.

Copper sulphate – Copper

Nickel sulphate – Nickel

Chromic acid – Chromium

## **Factors affecting electroplating**

The following are the factors affecting electroplating:

1. Cleaning of the article is essential for a strong adherent electroplating.
2. Concentration of the electrolyte is a major factor in electroplating.
3. Low concentration of metal ions will produce uniform coherent metal deposition.
4. Thickness of the deposit should be minimized in order to get a strong adherent coating.



5. Additives such as glue and boric acid should be added to the electrolytic bath to get a strong adherent and smooth coating.
6. The electrolyte selected should be highly soluble and should not undergo any chemical reaction.
7. The pH of the electrolytic bath must be properly maintained to get the deposition effectively.

## INORGANIC COATING

### **Anodizing:**

**Anodizing is the process of coating aluminium oxide on the surface of aluminium or its alloy.**

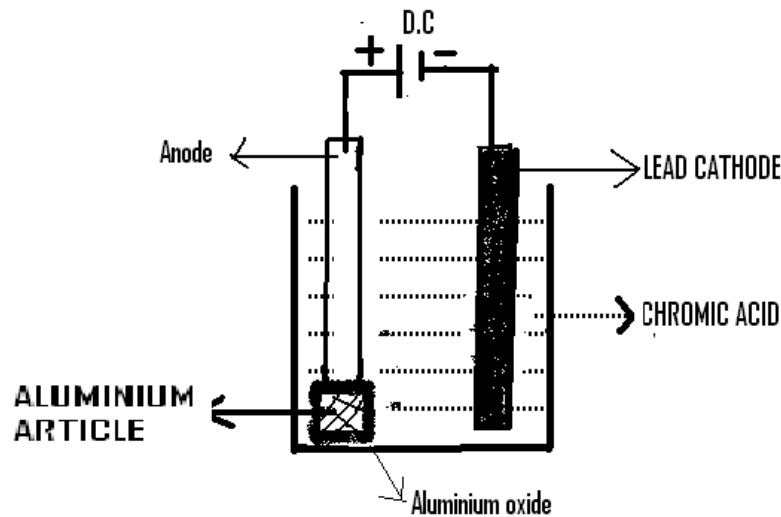

This type of coating is produced on non ferrous metals like Al, Zn, Mg and their alloys, by anodic oxidation process, by passing direct electric current through a bath in which the metal is suspended from anode. Here the base metal behaves as an anode. For anodizing 8% sulphuric acid is used as the electrolyte. Since it is a good oxidising agent, it oxidises aluminium (at the anode) into aluminium oxide. The electrolytes are sulphuric, chromic, phosphoric, oxalic or boric acid.

Anodized coatings have more corrosion resistance due to thicker coating.

'Aluminium oxide coatings' are formed by the oxidation taking place on the aluminium surface at moderate temperatures (35 to 40°C) and moderate current densities. The formed oxide film is initially thin and gain thickness by the continuous oxidation of aluminium anode. The surface of oxide film contains pores, which may cause corrosion. The pores can be sealed by exposing to boiling water, when the oxide is converted into monohydrate ( $\text{Al}_2\text{O}_3 \cdot \text{H}_2\text{O}$ ). This process is called sealing process.

The anodized aluminium and its alloy are used in: 1. aircrafts 2. window frames 3. machine parts 4. fancy article and 5. Refrigerator, etc.

## Cathodic Protection:

The principle involved in cathodic protection is to force the metal behave like a cathode. Since there will not be any anodic area on the metal, corrosion does not occur. There are two types of cathodic protection.

**(a) Sacrificial anodic protection.**

**(b) Impressed current cathodic protection.**

### **(a) Sacrificial Anodic Protection:**

In this technique, a more active metal is connected to the metal structure to be protected so that all the corrosion is concentrated at the more active metal and thus saving the metal structure from corrosion. This method is used for the protection of sea going vessels such as ships and boats. Sheets of zinc or magnesium are hung around the hull of the ship. Zinc and magnesium being anodic to iron get corroded. Since they are sacrificed in the process of saving iron (anode), they are called sacrificial anodes. The corroded sacrificial anode is replaced by a fresh one, when consumed completely.

Important applications of sacrificial anodic protection are as follows:

- (i) Protection from soil corrosion of underground cables and pipelines.
- (ii) Magnesium sheets are inserted into domestic water boilers to prevent the formation of rust.

### **(b) Impressed current cathodic protection:**

In this method, an impressed current is applied in an opposite direction to nullify the corrosion current and converting the corroding metal from anode to cathode. This can be accomplished by applying sufficient amount of direct current from a battery to an anode buried in the soil and connected to the corroding metal structure which is to be protected.

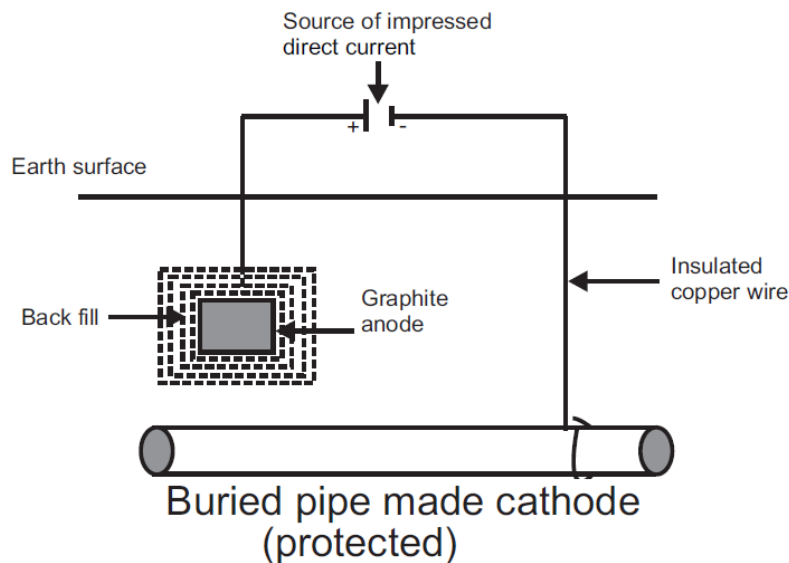

**FIGURE: IMPRESSED CATHODIC PROTECTION**

The anode is in a backfill (composed of gypsum) so as to increase the electrical contact with the soil. Since in this method current from an external source is impressed on the system, this is called impressed current method

This type of protection is given in the case of buried structures such as tanks and pipelines.

**SUMMARY:**

In this lesson, prevention of corrosion, Control of environment, Alloying, Surface coatings, Metal coatings, Electroplating, Galvanization and Tinning, Inorganic coating, Anodizing, Cathodic Protection, Sacrificial Anode Method and Impressed Voltage Method are discussed.

**Question:**

**PART -A**

1. What is Galvanization?
2. What is anoding?
3. What is base metal?
4. What is coat metal?
5. Galvanizing is preferred to tinning. Why?
6. What is Sherardizing?

**PART -B**

1. What is a sacrificial anode? How does it function?
2. Differentiate between galvanizing and tinning.
3. What is anodizing? How it is carried out? what are its applications?.
4. What is tinning? What are its merits & demerits?

**PART-C**

1. Explain the various methods of prevention of corrosion.
2. Explain briefly about cathodic protection.
3. Explain briefly about electroplating.

(TEST YOUR UNDERSTANDING)

1. Why is moderate current density employed during electroplating?
2. Chromium anode is not used in chromium plating. Give Reason.

## 5.3 ORGANIC COATINGS

### INTRODUCTION

Organic coating includes paints and varnishes. In this lesson, we are going to study about paint and its components. A little introduction to special paints used is also discussed. Further we are going to study about varnish its types and their preparation.

### PAINTS

#### DEFINITION

**Paint is a dispersion of pigment in drying oil.**

Paint coating is given to both metallic and wooden articles to protect them from corrosion and to give better surface appearance. Paint covers the manufacturing defects in the articles.

When paint is applied to a metal surface, the thinner evaporates while the drying oil slowly oxidizes forming of pigmented film.

#### Components of paints and their functions

The important constituents of paint are as follows.

1. Pigments
2. Vehicle or drying oils or medium
3. Thinners
4. Driers
5. Fillers or extenders
6. Plasticizers
7. Antiskinning agents

#### 1. Pigment:

A pigment is a solid and colour-producing substance which gives desired colour to the paint.

#### Example:

White pigments -- Titanium oxide, Zinc oxide.

Black pigments -- Graphite, Carbon black.

Red pigments -- Red Lead, Indian red ( $\text{Fe}_2\text{O}_3$ ).

#### Functions:

The following are the functions of the pigment:

- (a) A pigment gives opacity and colour to the film.
- (b) It covers the manufacturing defects.
- (c) A pigment gives strength to the film.
- (d) It protects the film by reflecting the destructive ultraviolet rays.

## **2. Vehicle or drying oils or medium:**

The liquid portion in which the pigment is dispersed is called a medium or vehicle.

### **Example:**

Linseed oil, dehydrated castor oil, soybean oil and fish oil.

### **Functions:**

- (a) Vehicles hold the pigment particles together on the metal surface.
- (b) They form the protective film by evaporation or by oxidation and polymerization of the unsaturated constituents of the oil.
- (c) Vehicles give better adhesion to the metal surface.
- (d) They impart water repellency, durability and toughness to the film.

## **3. Thinner:**

Thinners are added to paints to reduce the viscosity of the paints in order to make it easy to apply on the metal surface.

### **Example:**

Turpentine, kerosene and petroleum spirit.

### **Functions:**

1. Thinners reduce the viscosity of the paint to render it easy to handle and apply to the metal surface.
2. They dissolve the oil, pigments etc. and produce a homogeneous mixture.
3. Thinners evaporate rapidly and help the drying of the film.
4. They increase the elasticity of the film.

## **4. Driers:**

Driers are used to speed up the drying process and accelerate the drying of the oil film by oxidation, polymerization and condensation.

### **Example:**

Naphthentates and Resinates of lead, cobalt and manganese.

### **Functions:**

Driers act as oxygen carrier catalysts which help the absorption of oxygen and catalyze the drying of the oil film by oxidation, polymerization and condensation.

## **5. Fillers or extenders:**

Fillers are used to increase the volume of the paint and to reduce the cost. It increases the durability of the paint,.

### **Example:**

Asbestos, talc, china clay, calcium sulphate and calcium carbonate.

**Functions:**

- (a) Fillers serve to fill the voids in the film.
- (b) They reduce the cracking of the paints.
- (c) Fillers increase the durability of the paints.
- (d) They reduce the cost of the paint.

**6. Plasticizers:**

Plasticizers are chemicals added to increase elasticity of the film and to prevent cracking of the film.

**Example:**

Tertiary amyl alcohol, triphenyl phosphate, triglyceryl phosphate.

**7. Antiskinning agents:**

They are chemicals added to the paint to prevent skinning of the paint.

**Example:**

Polyhydroxy phenols, guaiacol, etc.

**VARNISHES****Definition**

**Varnish is a homogenous colloidal dispersion of natural or synthetic resin in oil or spirit medium.**

If the medium is oil it is known as oil varnishes.

If the medium is spirit it is known as spirit varnishes.

It is used as a protective and decorative coating to the wooden surfaces. It provides a hard, transparent, glossy appearance and durable film to the coated surface.

**There are two main types of varnishes**

1. Oil Varnish
2. Spirit Varnish

**Preparation of oil Varnish.**

Oil varnishes are more difficult to manufacture. Resins that are used in the preparation of oil varnishes are high molecular weight substances and are not easily soluble in oil. The resin is taken in an aluminium vessel and heated over a fire pit or in a small furnace. When resin melts, the temperature is slowly increased to about 300°C. This process is known as **gum running**. Some cracking or depolymerization of the resin takes place and about 25 per cent of the resin is lost in the form of fumes.

The required quantity (about 25 per cent of the weight of the resin) of boiled oil or linseed oil along with driers is separately heated to 200 to 220°C and is slowly added to the heated resin with constant stirring until thorough

combination has taken place. This operation is known as **cooking**. Over heating must be avoided as it causes discoloration of the varnish.

The kettle is removed from the furnace and allowed to cool, white spirit is then added (which is a petroleum fraction, boiling between 150<sup>0</sup>C and 200<sup>0</sup>C). It is the most common thinner.

The varnish is stored in tanks for some days for maturing. Foreign matter and particles of resin, which have not dissolved, settle during this period. During maturing, the colour of the varnish also improves and it becomes more homogenous. The varnish is filtered and packed for marketing.

## 2. SPIRIT VARNISHES

A Spirit varnish is a dispersion of resin in spirit.

### Preparation

The resin and spirit are placed in a cylindrical drum. plasticizer and other components are added. The resin is dissolved by agitating the mixture or by rotating the drum. It is then filtered and used. The final product is called spirit varnish.

### Difference between paint and varnish

Sl. No	Paint	Varnish
1.	Paint has pigment	There is no pigment in the varnish
2.	It can be applied to both metals & wooden articles	It can be applied only to the wooden articles
3.	It is Opaque	It is transparent

### Special paints

In addition to the normal ingredients some special chemicals are incorporated to paints for some specific purposes. They are commonly known as special paints.

#### 1. Luminous paints

Luminous paints are visible in the dark. Since it contain luminophor pigments (like CdS, ZnS) that are used for visibility in the dark .They absorb light radiations and emit them in the dark. The active components in luminous paint are specially prepared phosphorescent materials like CdS, ZnS, etc. For colour effect in luminous paints, certain chemicals like copper salts (green), silver salts (blue), cerium and uranium salts (yellow), etc. are added

#### Uses:

They find application in inks, advertising signboards, road marks, road traffic signs, number plates of vehicles, watch dials, map, chart, etc.

## **2. Fireretardant paints**

**The paints which retard the fire are called as fire-retardant.**

This paint contains the chemicals PVC, Chlorinated rubber, urea formaldehyde and carbonate pigments which are fire-resistant in nature. These substances at higher temperatures breakdown to give the non-inflammable gases like  $\text{CO}_2$ ,  $\text{NH}_3$ ,  $\text{HCl}$  and  $\text{HBr}$ . These gases are non-combustible and do not support combustion. Thus the fire is retarded.

### **Uses:**

Mainly used in defence, industrial, commercial, education and residential complexes

The most frequent source of a fire in any hotel, restaurant or residence. The walls, doors and even kitchen counters should be protected against the spread of fire.

False ceiling, Lift, Equipment Rooms, Aircraft Safe deposit vaults, lockers, Computer Server rooms, Power plants Chemical Plants, Storage Tanks, structures in Sugar Mills, Textile Mills and Floorings.

## **3. Aluminium Paint**

The base material in aluminium paint is a fine powder of aluminium. The ground fine powder of aluminium is suspended in either spirit varnish or an oil-varnish depending on the requirement. When paints are applied, the thinner evaporates and oil, if any, undergoes oxidation and polymerization. A bright adhering film of aluminium is obtained on the painted surface.

### **Uses:**

Wooden and metallic article for interior and exterior decoration.

### **Advantages of aluminium paint:**

1. It possesses a good covering power.
2. It imparts very attractive appearance to the surface.
3. It has fairly good heat-resistance.
4. It has very good electrical resistance
5. The painted film is waterproof.
6. The electrical surface is visible even darkness.
7. Corrosion protection for iron and steel surface is better than all other paints.

## **4. Distempers**

Distempers are water paints. They contain chalk powder, glue and pigment dissolved in water. They are very cheap and can be easily applied on walls. They are durable and give pleasing finish to walls. The ingredients of distemper are

1. Whiting agent or chalk powder (the base)
2. Glue or casein (the binder)
3. Colouring pigment and
4. Water (the solvent or thinner).



### **Advantages**

1. Distempers are cheaper than paints and varnishes
2. They can be applied easily on plasters and wall surfaces in the interior of the buildings.
3. They are durable.
4. They give smooth and pleasing finish to walls.

### **SUMMARY:**

In this lesson the organic coating like Paint, Components of Paints and their functions, Varnish Preparation of Oil Varnish, Differences between Paint and Varnish, Special Paints, Luminescent Paints, Fire retardant Paints, Aluminium Paints and Distemper are discussed.

### **QUESTIONS:**

#### **PART -A**

1. Define paint.
2. What is Varnish?
3. What is distemper?

#### **PART-B**

1. Write a short note on luminous paints.
2. Write a note on Aluminium paints.
3. Explain about Fire retardant paint.
4. What are the differences between paint and varnish?

#### **PART-C**

1. What are the components present in the paint. Explain their functions.
2. How is oil varnish preferred?
3. Explain briefly about special paints.

### **Test your understanding**

(Not for exam purpose)

1. What are toners?

# ***NOTES***

**SEMESTER – I**  
**ENGINEERING CHEMISTRY – I PRACTICAL**  
**VOLUMETRIC ANALYSIS**

The method to determine the exact amount of the substance in a given sample is termed as quantitative analysis. Volumetric analysis is a branch of quantitative analysis involving accurate measurement of volumes of reacting solutions. The volumetric analysis is very much in use due to simplicity, rapidity, accuracy and wide applicability.

The reacting substances are taken in the form of solutions and made to react. The concentration of one solution is determined using another suitable solution whose concentration is accurately known. A known volume of one solution is measured with a pipette and taken in a conical flask. The other solution is taken in a burette and run into the first solution till the chemical reaction is just complete. The volume of the second solution is read from the burette and the two volumes are compared.

**Various terms used in volumetric analysis are given below.**

**Titration**

The process of adding one solution from the burette to another in the conical flask in order to complete the chemical reaction is termed titration.

**End point**

It is the exact stage at which chemical reaction involved in the titration is just complete.

**Indicator**

It is a substance which will show the end point of the reaction by change of colour. For example, phenolphthalein and methyl orange are indicators used in acid-alkali titrations. Potassium permanganate itself acts as an indicator in potassium permanganate titrations.

**Acidimetry and alkalimetry Titration**

Acidimetry refers to the titration of alkali with a standard acid and alkalimetry refers to the titration of an acid with a standard alkali.

**Permanganometric Titration**

The titration involving  $\text{KMnO}_4$  is called permanganometric titration. In the presence of dilute  $\text{H}_2\text{SO}_4$ ,  $\text{KMnO}_4$  oxidises ferrous sulphate and ferrous ammonium sulphate to ferric sulphate and oxidises oxalic acid to  $\text{CO}_2$  and  $\text{H}_2\text{O}$ .

**Normality**

The strength of a solution is expressed in terms of normality. Normality is the number of gram equivalents of solute present in 1000 ml (1 litre) of the solution. It is represented by the symbol N.

### Decinormal solution

A solution of having the strength (Normality) of 0.1 N is called a decinormal solution.

### Law of volumetric analysis

Whenever two substances react together, they react in the ratio of their equivalent mass. One litre of a normal solution of a substance will react exactly with the same volume of a normal solution of another substance. In other words, equal normal solutions will exactly react with each other. This result is stated in the form of law of volumetric analysis.

If  $V_1$  ml of a solution of strength  $N_1$  is required for complete reaction by  $V_2$  ml of the second solution of strength  $N_2$ , then

$$V_1 N_1 = V_2 N_2$$

If any three factors ( $V_1$ ,  $V_2$  and  $N_1$ ) are known, the fourth factor  $N_2$  can be calculated.

The following formula is the important formula used in all volumetric estimations.

Mass of solute per litre of the solution = Equivalent mass x Normality

### Equivalent mass of some important compounds

Name of the compound	Equivalent mass
Hydrochloric acid	36.5
Sulphuric acid	49
Oxalic acid	63
Sodium carbonate	53
Sodium hydroxide	40
Potassium hydroxide	56.1
Potassium permanganate	31.6
Ferrous sulphate	278
Ferrous ammonium sulphate	392
Potassium dichromate	49.04
Copper sulphate	249.54
EDTA (Disodium salt)	372
Iron	55.85

**STATE BOARD OF TECHNICAL EDUCATION & TRAINING, TAMILNADU**  
**DIPLOMA IN ENGINEERING / TECHNOLOGY SYLLABUS**  
**M-SCHEME**  
**(Implements from the Academic year 2015 - 2016 onwards)**

Course Name: All Branches of Diploma in Engineering and Technology and Special Programmes except DMOP, HMCT and Film & TV

Subject Code: **30017**

Semester : I Semester

Subject Title: **ENGINEERING CHEMISTRY – I PRACTICAL**

**SCHEME OF INSTRUCTIONS AND EXAMINATION:**

**No. of Weeks per Semester: 15**

**Weeks**

Subject	Instructions		Examination			Duration
	Hours/ Week	Hours/ Semester	Marks			
			Internal Assessment/ Record	Board Examination	Total	
ENGINEERING CHEMISTRY – I PRACTICAL	2	30	25	75	100	3 Hours

**OBJECTIVES:**

1. At the end of the program the student will have knowledge about volumetric analysis in acidimetric, alkalimetric and permanganometric titration and their applications.
2. To get knowledge of estimation of total hardness, temporary and permanent hardness in the hard water sample.
3. To get knowledge about measurement of pH and to calculate Hydrogen ion concentration in a solution.

**ENGINEERING CHEMISTRY – I PRACTICAL  
 CONTENTS**

**Intellectual Skills**

1. Carrying out Volumetric titrations and calculation of masses
2. Knowing units for Concentrations of solutions

**Motor Skills**

1. Measure quantities accurately
2. Observe chemical reactions
3. Handle the apparatus carefully

### **Acidimetry and Alkalimetry**

1. Estimation of weak base (sodium carbonate) using a standard solution of sodium hydroxide and sulphuric acid as link solution  
[Test solution should be made up to 100 ml]
2. Estimation of strong base (sodium hydroxide) using a standard solution of sodium carbonate and sulphuric acid as link solution  
[Test solution should be made up to 100 ml]
3. Comparison of strengths of two acid solutions using a standard solution of sodium hydroxide
4. Comparison of strengths of two alkaline solutions using a standard solution of oxalic acid

### **Permanganometry**

5. Estimation of Mohr's salt using a standard solution of ferrous sulphate and potassium permanganate as link solution  
[Test solution should be made up to 100 ml]
6. Estimation of Iron in ferrous sulphate solution using a standard solution of ferrous ammonium sulphate and potassium permanganate as link solution  
[Test solution should be made up to 100 ml]
7. Comparison of strengths of two potassium permanganate solutions using a standard solution of ferrous sulphate

### **Water Analysis**

8. Estimation of total hardness of a water sample using EDTA
9. Determination of  $p^H$  using a  $p^H$  meter and calculation of hydrogen ion Concentrations in the solutions (For five given samples)  
**(This question may be given to any two students per batch).**

**A single experiment with different skilled value may be given for a batch. The ninth experiment (Determination of  $P^H$ ) may be given to any two students per batch.**

**INTERNAL ASSESSMENT/RECORD : 25 MARKS**  
**BOARD EXAMINATION : 75 MARKS**

## VOLUMETRIC ANALYSIS:

FOR	MARKS ALLOTTED
SHORT PROCEDURE	05
VIVA – VOCE	05
TITRATION – I	25
TITRATION – II	25
CALCULATIONS	15
TOTAL	75

## DETERMINATION OF pH:

FOR	MARKS ALLOTTED
ANSWER FOR SHORT QUESTIONS ON pH	05
VIVA – VOCE	05
DETERMINATION OF pH	40
CALCULATION OF $[H^+]$	25
TOTAL	75

## MODEL QUESTION PAPER

### MODEL 1:

**3 Hours**

Estimate the mass of Iron present in whole of the given ferrous sulphate solution using a standard solution of ferrous ammonium sulphate of strength 0.1N and an approximately decinormal solution of potassium permanganate.

### MODEL 2:

**3 Hours**

Calculate the total hardness of the given sample of water using a standard hard water solution of molarity 0.01M and an approximately decimolar solution of EDTA.

### MODEL 3:

**3 Hours**

Determine the pH of five given samples using pH meter and calculate the hydrogen ion concentration of the samples. (Any two students per batch).

## SCHEME OF EVALUATION

FOR	MARKS ALLOTTED
SHORT PROCEDURE	05
VIVA – VOCE	05
TITRATION – I	25
TITRATION – II	25
CALCULATIONS (3 x 5) (Titration - I, Titration - II & Calculations) (For Arithmetic errors 25% Marks may be reduced)	15
TOTAL	75

### VOLUMETRIC ANALYSIS:

Titration value accuracy for Titration – I and II:

Accuracy	MARKS
± 0.2 ml	25
above ± 0.2 ml to ± 0.4 ml	21
above ± 0.4 ml to ± 0.6 ml	17
above ± 0.6 ml	5

### DETERMINATION OF pH:

FOR	MARKS ALLOTTED
ANSWER FOR SHORT QUESTIONS ON pH	05
VIVA – VOCE	05
DETERMINATION OF pH (5 SAMPLES) (5 x 8)	40
CALCULATION OF $[H^+]$ (5 x 5)	25
TOTAL	75

pH value Accuracy:

Accuracy	MARKS
± 0.2	8
above ± 0.2 to ± 0.4	6
above ± 0.4	4

**List of Apparatus to be provided for each student in Chemistry Laboratory during the Engineering Chemistry – I Practical Classes/Board Examination in addition to the required Solutions:**

Sl.No.	Name of the Item	Quantity (Nos.)
1	Beaker (100 ml)	1
2	Burette (50 ml)	1
3	Burette Stand	1
4	Conical Flask (250 ml)	1
5	Funnel	1
6	Pipette (20 ml)	1
7	Porcelain Tile	1
8	Standard Flask (100 ml)	1
9	Wash Bottle	1



# ***NOTES***

**TITRATION – I**  
**Sulphuric acid Vs Sodium hydroxide**

Sl. No.	Volume of Sodium hydroxide solution (V <sub>2</sub> ml)	Burette Reading		Volume of Sulphuric acid solution (V <sub>1</sub> ml)	Indicator
		Initial (ml)	Final (ml)		
1	20	0			Phenolphthalein
2	20	0			
3	20	0			
				Concordant value =	ml

Calculation:

Volume of Sulphuric acid solution (V<sub>1</sub>) =            ml

Normality of Sulphuric acid solution (N<sub>1</sub>) =    ?    N

Volume of Sodium hydroxide solution (V<sub>2</sub>) = 20    ml

Normality of Sodium hydroxide solution (N<sub>2</sub>) =            N

By the principle of Volumetric Analysis,

$$\begin{aligned}
 V_1 N_1 &= V_2 N_2 \\
 N_1 &= \frac{V_2 N_2}{V_1} \\
 N_1 &= \frac{20 \times \quad}{\quad} \\
 &= \dots\dots\dots \text{ N}
 \end{aligned}$$

The normality of Sulphuric acid solution =            N

## 1. ESTIMATION OF SODIUM CARBONATE

Ex. No.:

Date:

### Aim

To estimate the amount of sodium carbonate present in whole of the given solution using a standard solution of sodium hydroxide of normality ...0.1N and an approximately decinormal solution of sulphuric acid.

### Principle

The titration is based on the neutralisation reaction between sulphuric acid and sodium hydroxide in titration – I and sulphuric acid and sodium carbonate in titration – II.

### Procedure

#### Short Procedure

DESCRIPTION	TITRATION - I	TITRATION - II
Burette solution	Sulphuric acid solution	Sulphuric acid solution
Pipette solution	Sodium hydroxide solution	Sodium carbonate solution
Indicator	Phenolphthalein	Methyl orange
End point	Disappearance of pale pink colour	Appearance of permanent pink colour
Equivalent mass of sodium carbonate = 53		

#### Titration – I

##### Standardisation of Sulphuric acid solution

The burette is washed with water, rinsed with distilled water and then with the given sulphuric acid solution. It is filled with same acid up to zero mark. The initial reading of the burette is noted. A 20 ml pipette is washed with water, rinsed with distilled water and then with the given sodium hydroxide solution. 20 ml of sodium hydroxide solution is pipetted out into a clean conical flask. Two drops of phenolphthalein indicator is added into the flask. The solution turns pale pink in colour. The solution is titrated against sulphuric acid taken in the burette. The end point of the titration is the disappearance of pale pink colour to give colourless solution. The titration is repeated to get the concordant value. From the titre value, the normality of sulphuric acid solution is calculated.

## TITRATION – II

### Sulphuric acid Vs Sodium carbonate

Sl. No.	Volume of Sodium carbonate solution (V <sub>2</sub> ml)	Burette Reading		Volume of Sulphuric acid solution (V <sub>1</sub> ml)	Indicator
		Initial (ml)	Final (ml)		
1	20	0			Methyl orange
2	20	0			
3	20	0			
				Concordant value =	ml

Calculation:

Volume of sulphuric acid solution (V<sub>1</sub>) =                      ml

Normality of sulphuric acid solution (N<sub>1</sub>) =                      N

Volume of Sodium carbonate solution (V<sub>2</sub>) = 20                      ml

Normality of Sodium carbonate solution (N<sub>2</sub>) = ?                      N

By the principle of Volumetric Analysis,

$$\begin{aligned}
 V_1 N_1 &= V_2 N_2 \\
 N_2 &= \frac{V_1 N_1}{V_2} \\
 &= \frac{x}{20} \\
 &= \dots\dots\dots N
 \end{aligned}$$

The normality of Sodium carbonate solution =                      N

The amount of Sodium carbonate present in whole of the given solution } =  $\frac{\text{Equivalent mass} \times \text{Normality}}{10}$

=  $\frac{x}{10}$

=                      grams

## Titration – II

### Standardisation of Sodium carbonate solution

The given sodium carbonate solution is made up to 100 ml in a 100 ml standard flask. The solution is thoroughly shaken to get a uniformly concentrated solution. A 20 ml pipette is washed with water, rinsed with distilled water and then with the given sodium carbonate solution. 20 ml of sodium carbonate solution is pipetted out into a clean conical flask. Two drops of methyl orange indicator is added into the flask. The solution turns pale yellow in colour. The solution is titrated against standardised sulphuric acid solution taken in the burette. The end point of the titration is the change in colour from pale yellow to permanent pink colour. The titration is repeated to get the concordant value. From the titre value, the normality of sodium carbonate solution is calculated. From the normality of sodium carbonate solution, the amount of sodium carbonate present in whole of the given solution is calculated.

### Result

1. The normality of Sulphuric acid solution = N
2. The normality of Sodium carbonate solution = N
3. The amount of Sodium carbonate } = g  
Present in whole of the given solution }

**TITRATION – I**  
**Sulphuric acid Vs Sodium carbonate**

Sl.No	Volume of Sodium carbonate solution (V <sub>2</sub> ml)	Burette Reading		Volume of Sulphuric acid solution (V <sub>1</sub> ml)	Indicator
		Initial (ml)	Final (ml)		
1	20	0			Methyl orange
2	20	0			
3	20	0			
				Concordant value =	ml

Calculation:

Volume of Sulphuric acid solution (V<sub>1</sub>) =            ml  
 Normality of Sulphuric acid solution (N<sub>1</sub>) =        ?    N  
 Volume of Sodium carbonate solution (V<sub>2</sub>) =        20    ml  
 Normality of Sodium carbonate solution (N<sub>2</sub>) =            N

By the principle of Volumetric Analysis,

$$\begin{aligned}
 V_1 N_1 &= V_2 N_2 \\
 N_1 &= \frac{V_2 N_2}{V_1} \\
 N_1 &= \frac{20 \times}{\quad} \\
 &= \dots\dots\dots N
 \end{aligned}$$

The normality of Sulphuric acid solution =            N

## 2. ESTIMATION OF SODIUM HYDROXIDE

Ex. No.:

Date:

### Aim

To estimate the amount of sodium hydroxide present in whole of the given solution using a standard solution of sodium carbonate of normality 0.1 N and an approximately decinormal solution of sulphuric acid.

### Principle

The titration is based on the neutralisation reaction between sulphuric acid and sodium carbonate in titration – I and sulphuric acid and sodium hydroxide in titration – II.

### Procedure

#### Short Procedure

DESCRIPTION	TITRATION - I	TITRATION - II
Burette solution	Sulphuric acid solution	Sulphuric acid solution
Pipette solution	Sodium carbonate solution	Sodium hydroxide solution
Indicator	Methyl orange	Phenolphthalein
End point	Appearance of permanent pink colour	Disappearance of pale pink colour
Equivalent mass of sodium hydroxide = 40		

#### Titration – I

##### Standardisation of Sulphuric acid solution

The burette is washed with water, rinsed with distilled water and then with the given sulphuric acid solution. It is filled with same acid up to zero mark. The initial reading of the burette is noted. A 20 ml pipette is washed with water, rinsed with distilled water and then with the given sodium carbonate solution. 20 ml of sodium carbonate solution is pipetted out into a clean conical flask. Two drops of methyl orange indicator is added into the flask. The solution turns pale yellow in colour. The solution is titrated against sulphuric acid solution taken in the burette. The end point of the titration is the change in colour from pale yellow to permanent pink colour. The titration is repeated to get the concordant value. From the titre value, the normality of sulphuric acid solution is calculated.

**TITRATION – II**  
**Sulphuric acid Vs Sodium hydroxide**

Sl.No.	Volume of Sodium hydroxide solution (V <sub>2</sub> ml)	Burette Reading		Volume of Sulphuric acid solution (V <sub>1</sub> ml)	Indicator
		Initial (ml)	Final (ml)		
1	20	0			Methyl orange
2	20	0			
3	20	0			
				Concordant value =	ml

Calculation:

Volume of Sulphuric acid solution (V<sub>1</sub>) =                      ml

Normality of Sulphuric acid solution (N<sub>1</sub>) =                      N

Volume of Sodium hydroxide solution (V<sub>2</sub>) =            20            ml

Normality of Sodium hydroxide solution (N<sub>2</sub>) =            ?            N

By the principle of Volumetric Analysis,

$$\begin{aligned}
 V_1 N_1 &= V_2 N_2 \\
 N_2 &= \frac{V_1 N_1}{V_2} \\
 &\quad \times \\
 N_2 &= \frac{\quad}{20} \\
 &= \dots\dots\dots \text{ N}
 \end{aligned}$$

The normality of Sodium hydroxide solution =                      N

$$\begin{aligned}
 \left. \begin{array}{l} \text{The amount of Sodium} \\ \text{hydroxide present in whole} \\ \text{of the given solution} \end{array} \right\} &= \frac{\text{Equivalent mass x Normality}}{10} \\
 &= \frac{\quad \times}{10} \\
 &= \quad \text{grams}
 \end{aligned}$$



## Titration – II

### Standardisation of Sodium hydroxide solution

The given sodium hydroxide solution is made up to 100 ml in a 100 ml standard flask. The solution is thoroughly shaken to get a uniformly concentrated solution. A 20 ml pipette is washed with water, rinsed with distilled water and then with the given sodium hydroxide solution. 20 ml of sodium hydroxide solution is pipetted out into a clean conical flask. Two drops of phenolphthalein indicator is added into the flask. The solution turns pale pink in colour. The solution is titrated against sulphuric acid taken in the burette. The end point of the titration is the disappearance of pale pink colour to give colourless solution. The titration is repeated to get the concordant value. From the titre value, the normality of sodium hydroxide solution is calculated. From the normality of sodium hydroxide solution, the amount of sodium hydroxide present in whole of the given solution is calculated.

### Result

1. The normality of Sulphuric acid solution = N
2. The normality of Sodium hydroxide solution = N
3. The amount of Sodium hydroxide } = g  
Present in whole of the given solution }

**TITRATION – I**  
**Hydrochloric acid (A) Vs Sodium hydroxide**

Sl.No.	Volume of Sodium hydroxide solution  (V <sub>2</sub> ml)	Burette Reading		Volume of Hydrochloric acid (A) solution (V <sub>1</sub> ml)	Indicator
		Initial (ml)	Final (ml)		
1	20	0			Phenolphthalein
2	20	0			
3	20	0			
				Concordant value =	ml

Calculation:

Volume of Hydrochloric acid (A) solution (V<sub>1</sub>) =                      ml  
 Normality of Hydrochloric acid (A) solution (N<sub>1</sub>) =                      ?      N  
 Volume of Sodium hydroxide solution (V<sub>2</sub>) =                      20      ml  
 Normality of Sodium hydroxide solution (N<sub>2</sub>) =                      N

By the principle of Volumetric Analysis,

$$\begin{aligned}
 V_1 N_1 &= V_2 N_2 \\
 N_1 &= \frac{V_2 N_2}{V_1} \\
 N_1 &= \frac{20 \times}{\quad} \\
 &= \dots\dots\dots \text{ N}
 \end{aligned}$$

The normality of Hydrochloric acid (A) solution = ..... N

### 3. COMPARISON OF STRENGTHS OF TWO ACIDS

Ex. No.:

Date:

#### Aim

To compare the strengths of two hydrochloric acid solutions in bottles A and B and estimate the amount of hydrochloric acid present in 250 ml of the given weaker solution using a standard solution of sodium hydroxide of normality N.

#### Principle

The titration is based on the neutralisation reaction between hydrochloric acid (A) and sodium hydroxide in titration – I and hydrochloric acid (B) and sodium hydroxide in titration – II.

#### Procedure

##### Short Procedure

DESCRIPTION	TITRATION - I	TITRATION - II
Burette solution	Hydrochloric acid (A) solution	Hydrochloric acid (B) solution
Pipette solution	Sodium hydroxide solution	Sodium hydroxide solution
Indicator	Phenolphthalein	Phenolphthalein
End point	Disappearance of pale pink colour	Disappearance of pale pink colour
Equivalent mass of hydrochloric acid = 36.5		

#### Titration – I

##### Standardisation of Hydrochloric acid (A) solution

The burette is washed with water, rinsed with distilled water and then with the given hydrochloric acid (A) solution. It is filled with same acid up to zero mark. The initial reading of the burette is noted. A 20 ml pipette is washed with water, rinsed with distilled water and then with the given sodium hydroxide solution. 20 ml of sodium hydroxide solution is pipetted out into a clean conical flask. Two drops of phenolphthalein indicator is added into the flask. The solution turns pale pink in colour. The solution is titrated against hydrochloric acid (A) solution taken in the burette. The end point of the titration is the disappearance of pale pink colour to give colourless solution. The titration is repeated to get the concordant value. From the titre value, the normality of hydrochloric acid (A) solution is calculated.

**TITRATION – II**  
**Hydrochloric acid (B) Vs Sodium hydroxide**

Sl.No.	Volume of Sodium hydroxide solution  (V <sub>2</sub> ml)	Burette Reading		Volume of Hydrochloric acid (B) solution (V <sub>1</sub> ml)	Indicator
		Initial (ml)	Final (ml)		
1	20	0			Phenolphthalein
2	20	0			
3	20	0			
				Concordant value =	ml

Calculation:

Volume of Hydrochloric acid (B) solution (V<sub>1</sub>) =                      ml

Normality of Hydrochloric acid (B) solution (N<sub>1</sub>) =                      ?      N

Volume of Sodium hydroxide solution (V<sub>2</sub>) =                      20      ml

Normality of Sodium hydroxide solution (N<sub>2</sub>) =                      N

By the principle of Volumetric Analysis,

$$\begin{aligned}
 V_1 N_1 &= V_2 N_2 \\
 N_1 &= \frac{V_2 N_2}{V_1} \\
 N_1 &= \frac{20 \times \quad}{\quad} \\
 &= \dots\dots\dots N
 \end{aligned}$$

The normality of Hydrochloric acid (B) solution =                      N

Hydrochloric acid ( ) solution is **weaker** than Hydrochloric acid ( ) solution

$$\begin{aligned}
 \left. \begin{array}{l} \text{The amount of Hydrochloric acid} \\ \text{present in 250 ml of the given} \\ \text{weaker solution} \end{array} \right\} &= \frac{\text{Equivalent mass} \times \text{Normality} \times 250}{1000} \\
 &= \frac{\quad \times \quad}{1000} \\
 &= \quad \text{grams}
 \end{aligned}$$

## Titration – II

### Standardisation of Hydrochloric acid (B) solution

The burette is washed with water, rinsed with distilled water and then with the given hydrochloric acid (B) solution. It is filled with same acid up to zero mark. The initial reading of the burette is noted. A 20 ml pipette is washed with water, rinsed with distilled water and then with the given sodium hydroxide solution. 20 ml of sodium hydroxide solution is pipetted out into a clean conical flask. Two drops of phenolphthalein indicator is added into the flask. The solution turns pale pink in colour. The solution is titrated against hydrochloric acid (B) solution taken in the burette. The end point of the titration is the disappearance of pale pink colour to give colourless solution. The titration is repeated to get the concordant value. From the titre value, the normality of hydrochloric acid (B) solution is calculated. The normalities of two hydrochloric acid solutions are compared and then the amount of hydrochloric acid present in 250 ml of the given weaker solution is calculated.

### Result

1. The normality of Hydrochloric acid (A) solution = N
2. The normality of Hydrochloric acid (B) solution = N
3. Hydrochloric acid ( ) solution is **weaker** than  
Hydrochloric acid ( ) solution
4. The amount of Hydrochloric acid } = g  
Present in 250 ml of the given weaker solution }

## TITRATION – I

### Oxalic acid Vs Sodium hydroxide (A)

Sl. No.	Volume of Sodium hydroxide (A) solution (V <sub>2</sub> ml)	Burette Reading		Volume of Oxalic acid solution (V <sub>1</sub> ml)	Indicator
		Initial (ml)	Final (ml)		
1	20	0			Phenolphthalein
2	20	0			
3	20	0			
				Concordant value =	ml

Calculation:

Volume of Oxalic acid solution (V<sub>1</sub>) =                      ml

Normality of Oxalic acid solution (N<sub>1</sub>) =                      N

Volume of Sodium hydroxide (A) solution (V<sub>2</sub>) =                      20 ml

Normality of Sodium hydroxide (A) solution (N<sub>2</sub>) =                      ? N

By the principle of Volumetric Analysis,

$$\begin{aligned}
 V_1 N_1 &= V_2 N_2 \\
 N_2 &= \frac{V_1 N_1}{V_2} \\
 &= \frac{\quad \times}{20} \\
 &= \dots\dots\dots \text{N}
 \end{aligned}$$

The normality of Sodium hydroxide (A) solution =                      N

#### 4. COMPARISON OF STRENGTHS OF TWO BASES

Ex. No.:

Date:

##### Aim

To compare the strengths of two sodium hydroxide solutions in bottles A and B and estimate the amount of sodium hydroxide present in 500 ml of the given stronger solution using a standard solution of oxalic acid of normality.....N

##### Principle

The titration is based on the neutralisation reaction between oxalic acid and sodium hydroxide (A) in titration – I and oxalic acid and sodium hydroxide (B) in titration – II.

##### Procedure

##### Short Procedure

DESCRIPTION	TITRATION - I	TITRATION - II
Burette solution	Oxalic acid solution	Oxalic acid solution
Pipette solution	Sodium hydroxide (A) solution	Sodium hydroxide (B) solution
Indicator	Phenolphthalein	Phenolphthalein
End point	Disappearance of pink colour	Disappearance of pink colour
Equivalent mass of sodium hydroxide = 40		

##### Titration – I

##### Standardisation of Sodium hydroxide (A) solution

The burette is washed with water, rinsed with distilled water and then with the given oxalic acid solution. It is filled with same acid up to zero mark. The initial reading of the burette is noted. A 20 ml pipette is washed with water, rinsed with distilled water and then with the given sodium hydroxide (A) solution. 20 ml of sodium hydroxide (A) solution is pipetted out into a clean conical flask. Two drops of phenolphthalein indicator is added into the flask. The solution turns pale pink in colour. The solution is titrated against oxalic acid solution taken in the burette. The end point of the titration is the disappearance of pale pink colour to give colourless solution. The titration is repeated to get the concordant value. From the titre value, the normality of sodium hydroxide (A) solution is calculated.

## TITRATION – II

### Oxalic acid Vs Sodium hydroxide (B)

Sl.No.	Volume of Sodium hydroxide (B) solution (V <sub>2</sub> ml)	Burette Reading		Volume of Oxalic acid solution (V <sub>1</sub> ml)	Indicator
		Initial (ml)	Final (ml)		
1	20	0			Phenolphthalein
2	20	0			
3	20	0			
				Concordant value =	ml

Calculation:

Volume of Oxalic acid solution (V<sub>1</sub>) =                      ml

Normality of Oxalic acid solution (N<sub>1</sub>) =                      N

Volume of Sodium hydroxide (B) solution (V<sub>2</sub>) =                      20 ml

Normality of Sodium hydroxide (B) solution (N<sub>2</sub>) =                      ? N

By the principle of Volumetric Analysis,

$$V_1 N_1 = V_2 N_2$$

$$N_2 = \frac{V_1 N_1}{V_2}$$

$$N_2 = \frac{x}{20}$$

$$= \dots\dots\dots N$$

The normality of Sodium hydroxide (B) solution =                      N

Sodium hydroxide (    ) solution is stronger than Sodium hydroxide (    ) solution

The amount of Sodium hydroxide present in 500 ml of the given stronger solution } =  $\frac{\text{Equivalent mass} \times \text{Normality} \times 500}{1000}$

$$= \frac{x \quad x}{1000}$$

$$= \text{grams}$$



## Titration – II

### Standardisation of Sodium hydroxide (B) solution

The burette is washed with water, rinsed with distilled water and then with the given oxalic acid solution. It is filled with same acid up to zero mark. The initial reading of the burette is noted. A 20 ml pipette is washed with water, rinsed with distilled water and then with the given sodium hydroxide (B) solution. 20 ml of sodium hydroxide (B) solution is pipetted out into a clean conical flask. Two drops of phenolphthalein indicator is added into the flask. The solution turns pale pink in colour. The solution is titrated against oxalic acid solution taken in the burette. The end point of the titration is the disappearance of pale pink colour to give colourless solution. The titration is repeated to get the concordant value. From the titre value, the normality of sodium hydroxide (B) solution is calculated. The normalities of two sodium hydroxide solutions are compared and then the amount of sodium hydroxide present in 500 ml of the given stronger solution is calculated.

### Result

1. The normality of Sodium hydroxide (A) solution = N
2. The normality of Sodium hydroxide (B) solution = N
3. Sodium hydroxide ( ) solution is **stronger** than  
Sodium hydroxide ( ) solution
4. The amount of Sodium hydroxide } = g  
Present in 500 ml of the given stronger solution }

## TITRATION – I

### Potassium permanganate Vs Ferrous sulphate

Sl. No.	Volume of Ferrous sulphate solution (V <sub>2</sub> ml)	Burette Reading		Volume of Potassium permanganate solution (V <sub>1</sub> ml)	Indicator
		Initial (ml)	Final (ml)		
1	20	0			Self (KMnO <sub>4</sub> )
2	20	0			
3	20	0			
				Concordant value =	ml

Calculation:

Volume of Potassium permanganate solution (V<sub>1</sub>) =            ml

Normality of Potassium permanganate solution (N<sub>1</sub>) =        ?    N

Volume of Ferrous sulphate solution (V<sub>2</sub>) =    20    ml

Normality of Ferrous sulphate solution (N<sub>2</sub>) =            N

By the principle of Volumetric Analysis,

$$\begin{aligned}
 V_1 N_1 &= V_2 N_2 \\
 N_1 &= \frac{V_2 N_2}{V_1} \\
 N_1 &= \frac{20 \times}{\quad} \\
 &= \dots\dots\dots \text{ N}
 \end{aligned}$$

The normality of Potassium permanganate solution =            N

## 5. ESTIMATION OF MOHR'S SALT

Ex. No.:

Date:

### Aim

To estimate the amount of crystalline ferrous ammonium sulphate (Mohr's salt) present in whole of the given solution using a standard solution of ferrous sulphate of normality 0.1N and an approximately decinormal solution of potassium permanganate.

### Principle

The titration is based on the oxidation and reduction reaction. The oxidising agent, potassium permanganate oxidises the reducing agent, ferrous sulphate and ferrous ammonium sulphate in acidic medium to ferric sulphate.

### Procedure

#### Short Procedure

DESCRIPTION	TITRATION - I	TITRATION - II
Burette solution	Potassium permanganate solution	Potassium permanganate solution
Pipette solution	Ferrous sulphate solution	Ferrous ammonium sulphate solution
Reagents added	20 ml of dilute sulphuric acid	20 ml of dilute sulphuric acid
Indicator	Self (KMnO <sub>4</sub> )	Self (KMnO <sub>4</sub> )
End point	Appearance of pale permanent pink colour	Appearance of pale permanent pink colour
Equivalent mass of ferrous ammonium sulphate = 392		

#### Titration – I

##### Standardisation of Potassium permanganate solution

The burette is washed with water, rinsed with distilled water and then with the given potassium permanganate solution. It is filled with same solution up to zero mark. The initial reading of the burette is noted. A 20 ml pipette is washed with water, rinsed with distilled water and then with the given ferrous sulphate solution. 20 ml of ferrous sulphate solution is pipetted out into a clean conical flask. One test tube of sulphuric acid (20 ml) is added into the flask. The solution is titrated against potassium permanganate solution taken in the burette. Potassium permanganate acts as the self-indicator. The end point of the titration is the appearance of pale permanent pink colour. The titration is repeated to get the concordant value. From the titre value, the normality of potassium permanganate solution is calculated.

## TITRATION – II

### Potassium permanganate Vs Ferrous ammonium sulphate

Sl.No.	Volume of Ferrous ammonium sulphate solution (V <sub>2</sub> ml)	Burette Reading		Volume of Potassium permanganate solution (V <sub>1</sub> ml)	Indicator
		Initial (ml)	Final (ml)		
1	20	0			Self (KMnO <sub>4</sub> )
2	20	0			
3	20	0			
				Concordant value =	ml

Calculation:

Volume of Potassium permanganate solution (V<sub>1</sub>) =                      ml

Normality of Potassium permanganate solution (N<sub>1</sub>) =                      N

Volume of Ferrous ammonium sulphate solution (V<sub>2</sub>) =                      20 ml

Normality of Ferrous ammonium sulphate solution (N<sub>2</sub>) =                      ? N

By the principle of Volumetric Analysis,

$$\begin{aligned}
 V_1 N_1 &= V_2 N_2 \\
 N_2 &= \frac{V_1 N_1}{V_2} \\
 &= \frac{\quad \times}{20} \\
 &= \dots\dots\dots N
 \end{aligned}$$

The normality of Ferrous ammonium sulphate solution =                      N

$$\begin{aligned}
 \left. \begin{array}{l} \text{The amount of Ferrous} \\ \text{ammonium sulphate present} \\ \text{in whole of the given solution} \end{array} \right\} &= \frac{\text{Equivalent mass} \times \text{Normality}}{10} \\
 &= \frac{\quad \times}{10} \\
 &= \quad \text{grams}
 \end{aligned}$$

## Titration – II

### Standardisation of Ferrous ammonium sulphate (Mohr's salt) solution

The given ferrous ammonium sulphate (Mohr's salt) solution is made up to 100 ml in a 100 ml standard flask. The solution is thoroughly shaken to get a uniformly concentrated solution. A 20 ml pipette is washed with water, rinsed with distilled water and then with the given ferrous ammonium sulphate solution. 20 ml of ferrous ammonium sulphate solution is pipetted out into a clean conical flask. One test tube of sulphuric acid (20 ml) is added into the flask. The solution is titrated against standardised potassium permanganate solution taken in the burette. Potassium permanganate acts as the self-indicator. The end point of the titration is the appearance of pale permanent pink colour. The titration is repeated to get the concordant value. From the titre value, the normality of ferrous ammonium sulphate solution is calculated. From the normality of ferrous ammonium sulphate solution, the amount of ferrous ammonium sulphate present in whole of the given solution is calculated.

### Result

1. The normality of Potassium permanganate solution = N
2. The normality of Ferrous ammonium sulphate solution = N
3. The amount of Ferrous ammonium sulphate } = g  
Present in whole of the given solution }

## TITRATION – I

### Potassium permanganate Vs Ferrous ammonium sulphate

Sl.No.	Volume of Ferrous ammonium sulphate solution (V <sub>2</sub> ml)	Burette Reading		Volume of Potassium permanganate solution (V <sub>1</sub> ml)	Indicator
		Initial (ml)	Final (ml)		
1	20	0			Self (KMnO <sub>4</sub> )
2	20	0			
3	20	0			
Concordant value =					ml

Calculation:

Volume of Potassium permanganate solution (V<sub>1</sub>) =                      ml

Normality of Potassium permanganate solution (N<sub>1</sub>) =                      ?      N

Volume of Ferrous ammonium sulphate solution (V<sub>2</sub>) =                      20      ml

Normality of Ferrous ammonium sulphate solution (N<sub>2</sub>) =                      N

By the principle of Volumetric Analysis,

$$\begin{aligned}
 V_1 N_1 &= V_2 N_2 \\
 N_1 &= \frac{V_2 N_2}{V_1} \\
 &= \frac{20 \times \quad}{\quad}
 \end{aligned}$$

$$N_1 = \dots\dots\dots N$$

The normality of Potassium permanganate solution =                      N

## 6. ESTIMATION OF IRON IN FERROUS SULPHATE

Ex. No.:

Date:

### Aim

To estimate the amount of iron present in whole of the given ferrous sulphate solution using a standard solution of ferrous ammonium sulphate of normality 0.0952 N and an approximately decinormal solution of potassium permanganate.

### Principle

The titration is based on the oxidation and reduction reaction. The oxidising agent, Potassium permanganate oxidises the reducing agent, ferrous sulphate and ferrous ammonium sulphate in acidic medium to ferric sulphate.

### Procedure

#### Short Procedure

DESCRIPTION	TITRATION - I	TITRATION - II
Burette solution	Potassium permanganate solution	Potassium permanganate solution
Pipette solution	Ferrous ammonium sulphate solution	Ferrous sulphate solution
Reagents added	20 ml of dilute sulphuric acid	20 ml of dilute sulphuric acid
Indicator	Self (KMnO <sub>4</sub> )	Self (KMnO <sub>4</sub> )
End point	Appearance of pale permanent pink colour	Appearance of pale permanent pink colour
Equivalent mass of iron = 55.85		

#### Titration – I

##### Standardisation of Potassium permanganate solution

The burette is washed with water, rinsed with distilled water and then with the given potassium permanganate solution. It is filled with same solution up to zero mark. The initial reading of the burette is noted. A 20 ml pipette is washed with water, rinsed with distilled water and then with the given ferrous ammonium sulphate solution. 20 ml of ferrous ammonium sulphate solution is pipetted out into a clean conical flask. One test tube of sulphuric acid (20 ml) is added into the flask. The solution is titrated against potassium permanganate solution taken in the burette. Potassium permanganate acts as the self-indicator. The end point of the titration is the appearance of pale permanent pink colour. The titration is repeated to get the concordant value. From the titre value, the normality of potassium permanganate solution is calculated.

## TITRATION – II

### Potassium permanganate Vs Ferrous sulphate

Sl.No.	Volume of Ferrous sulphate solution (V <sub>2</sub> ml)	Burette Reading		Volume of Potassium permanganate solution (V <sub>1</sub> ml)	Indicator
		Initial (ml)	Final (ml)		
1	20	0			Self (KMnO <sub>4</sub> )
2	20	0			
3	20	0			
				Concordant value =	ml

Calculation:

Volume of Potassium permanganate solution (V<sub>1</sub>) =                      ml

Normality of Potassium permanganate solution (N<sub>1</sub>) =                      N

Volume of Ferrous sulphate solution (V<sub>2</sub>) =                      20 ml

Normality of Ferrous sulphate solution (N<sub>2</sub>) =                      ? N

By the principle of Volumetric Analysis,

$$\begin{aligned}
 V_1 N_1 &= V_2 N_2 \\
 N_2 &= \frac{V_1 N_1}{V_2} \\
 &= \frac{x}{20} \\
 &= \dots\dots\dots N
 \end{aligned}$$

The normality of Ferrous sulphate solution =                      N

The amount of Iron present in whole of the given ferrous sulphate solution } =  $\frac{\text{Equivalent mass of Iron} \times \text{Normality of Ferrous sulphate}}{10}$

=  $\frac{x}{10}$

=                      grams



## Titration – II

### Standardisation of Ferrous sulphate solution

The given ferrous sulphate solution is made up to 100 ml in a 100 ml standard flask. The solution is thoroughly shaken to get a uniformly concentrated solution. A 20 ml pipette is washed with water, rinsed with distilled water and then with the given ferrous sulphate solution. 20 ml of ferrous sulphate solution is pipetted out into a clean conical flask. One test tube of sulphuric acid (20 ml) is added into the flask. The solution is titrated against standardised potassium permanganate solution taken in the burette. Potassium permanganate acts as the self-indicator. The end point of the titration is the appearance of pale permanent pink colour. The titration is repeated to get the concordant value. From the titre value, the normality of ferrous sulphate solution is calculated. From the normality of ferrous sulphate solution, the amount of iron present in whole of the given ferrous sulphate solution is calculated.

### Result

1. The normality of Potassium permanganate solution = N
2. The normality of Ferrous sulphate solution = N
3. The amount of iron present in whole } = g  
of the given Ferrous sulphate solution }

## TITRATION – I

### Potassium permanganate (A) Vs Ferrous sulphate

Sl.No.	Volume of Ferrous sulphate solution (V <sub>2</sub> ml)	Burette Reading		Volume of Potassium permanganate (A) solution (V <sub>1</sub> ml)	Indicator
		Initial (ml)	Final (ml)		
1	20	0			Self (KMnO <sub>4</sub> )
2	20	0			
3	20	0			
				Concordant value =	ml

Calculation:

Volume of Potassium permanganate (A) solution (V<sub>1</sub>) =            ml

Normality of Potassium permanganate (A) solution (N<sub>1</sub>) =    ?    N

Volume of Ferrous sulphate solution (V<sub>2</sub>) =    20    ml

Normality of Ferrous sulphate solution (N<sub>2</sub>) =            N

By the principle of Volumetric Analysis,

$$\begin{aligned}
 V_1 N_1 &= V_2 N_2 \\
 N_1 &= \frac{V_2 N_2}{V_1} \\
 &= \frac{20 \times \quad}{\quad} \\
 N_1 &= \dots\dots\dots N
 \end{aligned}$$

The normality of Potassium permanganate (A) solution =            N

## 7. COMPARISON OF STRENGTHS OF TWO POTASSIUM PERMANGANATE SOLUTIONS

Ex. No.:

Date:

### Aim

To compare the strengths of two potassium permanganate solutions in bottles A and B and estimate the amount of potassium permanganate present in 750 ml of the given weaker solution using a standard solution of ferrous sulphate of normality .....N.

### Principle

The titration is based on the oxidation and reduction reaction. The oxidising agent, Potassium permanganate oxidises the reducing agent, ferrous sulphate in acidic medium to ferric sulphate.

### Procedure

DESCRIPTION	TITRATION - I	TITRATION - II
Burette solution	Potassium permanganate (A) solution	Potassium permanganate (B) solution
Pipette solution	Ferrous sulphate solution	Ferrous sulphate solution
Reagents added	20 ml of dilute sulphuric acid	20 ml of dilute sulphuric acid
Indicator	Self (KMnO <sub>4</sub> )	Self (KMnO <sub>4</sub> )
End point	Appearance of pale permanent pink colour	Appearance of pale permanent pink colour
Equivalent mass of potassium permanganate = 31.6		

### Titration – I

#### Standardisation of Potassium permanganate (A) solution

The burette is washed with water, rinsed with distilled water and then with the given potassium permanganate (A) solution. It is filled with same solution up to zero mark. The initial reading of the burette is noted. A 20 ml pipette is washed with ferrous sulphate solution. 20 ml of ferrous sulphate solution is pipetted out into a clean conical flask. One test tube of sulphuric acid (20 ml) is added into the flask. The solution is titrated against potassium permanganate (A) solution taken in the burette. Potassium permanganate (A) acts as the self-indicator. The end point of the titration is the appearance of pale permanent pink colour. The titration is repeated to get the concordant value. From the titre value, the normality of potassium permanganate (A) solution is calculated.

## TITRATION – II

### Potassium permanganate (B) Vs Ferrous sulphate

Sl.No.	Volume of Ferrous sulphate solution (V <sub>2</sub> ml)	Burette Reading		Volume of Potassium permanganate (B) solution (V <sub>1</sub> ml)	Indicator
		Initial (ml)	Final (ml)		
1	20	0			Self (KMnO <sub>4</sub> )
2	20	0			
3	20	0			
Concordant value =					ml

Calculation

Volume of Potassium permanganate (B) solution (V<sub>1</sub>) =            ml

Normality of Potassium permanganate (B) solution (N<sub>1</sub>) = ?    N

Volume of Ferrous sulphate solution (V<sub>2</sub>) = 20    ml

Normality of Ferrous sulphate solution (N<sub>2</sub>) =            N

By the principle of Volumetric Analysis,

$$\begin{aligned}
 V_1 N_1 &= V_2 N_2 \\
 N_1 &= \frac{V_2 N_2}{V_1} \\
 &= \frac{20 \times x}{\quad} \\
 N_1 &= \dots\dots\dots N
 \end{aligned}$$

The normality of Potassium permanganate (B) solution =            N

Potassium permanganate ( ) solution is weaker than

Potassium permanganate ( ) solution

The amount of Potassium permanganate present in 750 ml of the given weaker solution

$$\begin{aligned}
 &= \frac{\text{Equivalent mass} \times \text{Normality} \times 750}{1000} \\
 &= \frac{x \quad \quad \quad x}{1000} \\
 &= \quad \quad \quad \text{grams}
 \end{aligned}$$

## Titration – II

### Standardisation of Potassium permanganate (B) solution

The burette is washed with water, rinsed with distilled water and then with the given potassium permanganate (B) solution. It is filled with same solution up to zero mark. The initial reading of the burette is noted. A 20 ml pipette is washed with ferrous sulphate solution. 20 ml of ferrous sulphate solution is pipetted out into a clean conical flask. One test tube of sulphuric acid (20 ml) is added into the flask. The solution is titrated against potassium permanganate (B) solution taken in the burette. Potassium permanganate (B) acts as the self-indicator. The end point of the titration is the appearance of pale permanent pink colour. The titration is repeated to get the concordant value. From the titre value, the normality of potassium permanganate (B) solution is calculated. The normalities of two potassium permanganate solutions are compared and then the amount of potassium permanganate present in 750 ml of the given weaker solution is calculated.

### Result

1. The normality of Potassium permanganate (A) solution = N
2. The normality of Potassium permanganate (A) solution = N
3. Potassium permanganate ( ) solution is **weaker** than Potassium permanganate ( ) solution
4. The amount of Potassium permanganate } = g  
Present in 750 ml of the given weaker solution }

**TITRATION – I**  
**EDTA Vs Standard Calcium chloride solution**

Sl.No	Volume of Standard calcium chloride solution (V <sub>2</sub> ml)	Burette Reading		Volume of EDTA solution (V <sub>1</sub> ml)	Indicator
		Initial (ml)	Final (ml)		
1	20	0			EBT
2	20	0			
3	20	0			
				Concordant value =	ml

Calculation:

Volume of EDTA solution (V<sub>1</sub>) =            ml  
Molarity of EDTA solution (M<sub>1</sub>) = ?    M  
Volume of Standard calcium chloride solution (V<sub>2</sub>) = 20    ml  
Molarity of Standard calcium chloride solution (M<sub>2</sub>) = 0.01    M

By the principle of Volumetric Analysis,

$$\begin{aligned}
 V_1 M_1 &= V_2 M_2 \\
 M_1 &= \frac{V_2 M_2}{V_1} \\
 &= \frac{\quad \times \quad}{\quad} \\
 &= \quad \quad \quad \text{M}
 \end{aligned}$$

The molarity of EDTA solution (M<sub>EDTA</sub>) =            M

## 8. ESTIMATION OF TOTAL HARDNESS OF WATER

Ex. No.:

Date:

### Aim

To estimate the total hardness of the given sample of water by EDTA titration.

### Principle

The total hardness of water can be determined by titrating a known volume of hard water against EDTA solution using Eriochrome Black – T indicator. The estimation is based on the complexometric titration.

### Procedure

#### Short Procedure

DESCRIPTION	TITRATION - I	TITRATION - II
Burette solution	EDTA solution	EDTA solution
Pipette solution	Standard calcium chloride solution	Hard water
Reagents added	Ammonia buffer solution	Ammonia buffer solution
Indicator	Eriochrome Black – T	Eriochrome Black – T
End point	Change in colour from wine red to steel blue	Change in colour from wine red to steel blue

#### Titration – I

##### Standardisation of EDTA solution

The burette is washed with water, rinsed with distilled water and then with the given EDTA solution. It is filled with same solution up to zero mark. The initial reading of the burette is noted. A 20 ml pipette is washed with water, rinsed with distilled water and then with the given standard calcium chloride solution. 20 ml of standard calcium chloride solution is pipetted out into a clean conical flask. Half a test tube of ammonia buffer (10 ml) is added into the flask. A pinch of Eriochrome Black – T indicator is added into the flask. The solution turns wine red in colour. The solution is titrated against EDTA solution taken in the burette. The end point of the titration is the change in colour from wine red to steel blue. The titration is repeated to get the concordant value. From the titre value, the molarity of EDTA solution is calculated.

**TITRATION – II**  
**EDTA Vs Hard water sample**

Sl.No	Volume of Hard water sample (V <sub>Hard water</sub> )	Burette Reading		Volume of EDTA solution (V <sub>EDTA</sub> )	Indicator
		Initial (ml)	Final (ml)		
1	20	0			EBT
2	20	0			
3	20	0			
				Concordant value =	ml

Calculation:

Volume of EDTA solution (V<sub>EDTA</sub>) = ml

Molarity of EDTA solution (M<sub>EDTA</sub>) = N

Volume of Hard water sample (V<sub>Hard water</sub>) = 20 ml

$$\begin{aligned}
 \text{Total Hardness} &= \frac{V_{EDTA} \times M_{EDTA}}{V_{Hard\ water}} \times 10^6 \\
 &= \frac{\quad \times \quad}{\quad} \times 10^6 \\
 &= \quad \text{ppm}
 \end{aligned}$$



## **Titration – II**

### **Standardisation of hard water**

A 20 ml pipette is washed with water, rinsed with distilled water and then with the given hard water sample. 20 ml of hard water sample is pipetted out into a clean conical flask. Half a test tube of ammonia buffer (10 ml) is added into the flask. A pinch of Eriochrome Black – T indicator is added into the flask. The solution turns wine red in colour. The solution is titrated against EDTA solution taken in the burette. The end point of the titration is the change in colour from wine red to steel blue. The titration is repeated to get the concordant value. From the titre value, the hardness of the given sample of water is calculated in ppm.

### **Result**

The total hardness of the given sample of water = \_\_\_\_\_ ppm

### DETERMINATION OF pH AND [H<sup>+</sup>]

Sl. No.	Sample solution	pH	[H <sup>+</sup> ] (g ions / litre)
1	A		
2	B		
3	C		
4	D		
5	E		

#### Calculations

##### 1. Sample A

$$\text{pH} =$$

$$\text{pH} = -\log_{10} [\text{H}^+]$$

$$[\text{H}^+] = \text{Antilog} (-\text{pH})$$

$$= \text{Antilog} (- \quad )$$

$$= \quad \text{g ions / litre}$$

##### 2. Sample B

$$\text{pH} =$$

$$\text{pH} = -\log_{10} [\text{H}^+]$$

$$[\text{H}^+] = \text{Antilog} (-\text{pH})$$

$$= \text{Antilog} (- \quad )$$

$$= \quad \text{g ions / litre}$$

##### 3. Sample C

$$\text{pH} =$$

$$\text{pH} = -\log_{10} [\text{H}^+]$$

$$[\text{H}^+] = \text{Antilog} (-\text{pH})$$

$$= \text{Antilog} (- \quad )$$

$$= \quad \text{g ions / litre}$$

##### 4. Sample D

$$\text{pH} =$$

$$\text{pH} = -\log_{10} [\text{H}^+]$$

$$[\text{H}^+] = \text{Antilog} (-\text{pH})$$

$$= \text{Antilog} (- \quad )$$

$$= \quad \text{g ions / litre}$$

##### 5. Sample E

$$\text{pH} =$$

$$\text{pH} = -\log_{10} [\text{H}^+]$$

$$[\text{H}^+] = \text{Antilog} (-\text{pH})$$

$$= \text{Antilog} (- \quad )$$

$$= \quad \text{g ions / litre}$$

## 9. DETERMINATION OF pH AND CALCULATION OF HYDROGEN ION CONCENTRATION

Ex. No.:

Date:

### Aim

To find out

1. The pH of the given solution in bottles A, B, C D and E.
2. To calculate the hydrogen ion concentrations of the above solutions.

### Principle

The pH of the solution can be directly measured using a pH meter. Acids give hydrogen ions in solution. The acidic nature of the solution depends on the hydrogen ion concentration which is expressed as grams ions per litre. The pH of the solution varies with the concentration of ions.

$$\text{pH} = -\log_{10} [\text{H}^+]$$

### Procedure

Exactly 50 ml of the given five sample solutions are taken in five 150 ml beakers and labeled as A, B, C, D and E. The pH meter is standardized using a known buffer solution. The electrodes are then washed with distilled water and then immersed in the solution taken in the beaker. The pH reading is noted. The pH of the other solutions is determined similarly. The electrodes are washed well with distilled water before the electrodes are immersed in next solution. The amount of hydrogen ions present in the solution is then calculated from the pH.

### Result

The pH and the hydrogen ion concentration of the five given sample solutions are:

	<b>pH</b>		<b>H<sup>+</sup> concentration</b>
1. Sample A =		and	g ions/litre
2. Sample B =		and	g ions/litre
3. Sample C =		and	g ions/litre
4. Sample D =		and	g ions/litre
5. Sample E =		and	g ions/litre

# ***NOTES***

**SECOND SEMESTER**  
**ENGINEERING CHEMISTRY-II (30025)**  
**UNIT- I**  
**ENVIRONMENTAL CHEMISTRY**

**1.1- AIR POLLUTION**

**Introduction**

In recent days, everyone speaks about pollution. We are all facing huge risks due to pollution. The air we breathe the water we drink and the place where we live and work in may be full of toxic substances. The adverse effects of these pollutants may affect the future generation also.

**Pollution**

**Pollution may be defined as the excessive discharge or addition of unwanted and undesirable foreign matters into the environment that causes huge damage to the life and properties of human, plants and animal.**

Environment includes air, water and land. The harmful substances that cause damage are called **pollutants**. They are discharged from various industries, automobiles, microorganism, volcanic eruptions, forests and strong winds.

**Causes of pollution**

The following are the main causes of pollution.

1. Huge increase in population.
2. Rapid industrialization.
3. Rapid urbanization.
4. Uncontrolled exploitation of nature.
5. Radioactive substances.
6. Volcanic eruptions, etc.

**Classification of pollution**

To understand the magnitude of pollution problems, it may be classified into three types as follows.

1. Air pollution
2. Water pollution
3. Land pollution

**Air pollution**

**Air Pollution may be defined as the excessive discharge or addition of unwanted and undesirable foreign matters into the atmosphere that causes huge damage to the life and properties of human, plants and animal.**

Gaseous pollutants like sulphur dioxide, hydrogen sulphide, hydrogen fluoride, carbon monoxide and dust are the most important primary air pollutants.

### Harmful effects of air pollutants

Sl. No.	Air pollutant	Source	Harmful effects
1	Sulphur dioxide (SO <sub>2</sub> )	Petroleum industry, thermal power station, sulphuric acid manufacturing plants, etc.	Causes respiratory diseases, eye irritation, throat troubles, damage to agriculture, etc.
2	Hydrogen sulphide (H <sub>2</sub> S)	Petroleum industries, paper industries, leather industries, etc.	Causes eye irritation, severe throat pain, headache, corrosion of metals, etc.
3	Hydrogen fluoride (HF)	Fertilizer industry, aluminium industry, etc.	Causes irritation, respiratory diseases, bone disorders, tooth disorders, etc.
4	Carbon monoxide (CO)	Automobile industry, oil refineries, cigarette smoke, etc.	Causes headache, visual difficulty, paralysis, etc.
5	Dust	Cement industry, mines, glass industry, ceramic industry, agricultural industry, etc.	Causes respiratory diseases, affects lungs, accelerates corrosion, etc.

### Acid rain

The gases like SO<sub>2</sub> and NO<sub>2</sub> emitted from various industries react with moisture present in the atmosphere to form corresponding acids. It means that rain water contains more acids. The rain water containing the acid is called acid rain. They slowly fall down on the earth as acid rain during snow fall or normal rainfall. This is called as acid rain.

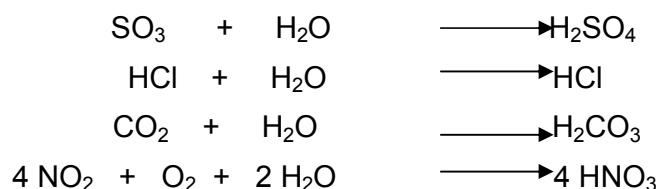

### Harmful effects of acid rain

1. Acid rain makes the soil more acidic and thereby reduces the fertility of the soil.
2. It affects the growth of crops, plants, etc.
3. It affects the survival of fishes and reduces the population of aquatic species.
4. It badly makes damage to buildings, vehicles, structural materials, etc.
5. It affects human being's life system and organs like skin, lungs and hair.
6. It damages the memorable monuments, buildings, etc. The famous 'Taj Mahal' is being affected severely.
7. It causes corrosion in metal.
8. Acid rain damages automobiles coatings and oil based paints.

### Green house effect

**The earth surface gets warmed due to the blanketing effect of pollutants like CO<sub>2</sub> present in the atmosphere. It is known as green house effect.**

Several radiations like UV, visible and infra-red rays from the sunlight reaches the earth surface and produce heat energy. Some of the heat that is absorbed by the earth's surface is radiated back into the space. The pollutants like CO<sub>2</sub> and other gases which form a blanket around the earth prevent the heat energy to escape from the surface of earth. Hence the earth gets warmed. It is similar to green glass houses where heat radiation cannot escape from them.

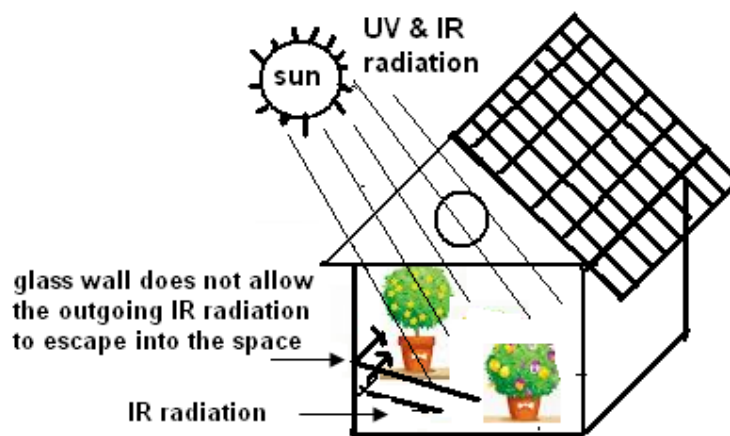

Green House effect

**Gases that cause green house effect are mainly CO<sub>2</sub>, methane, water vapour and chloro fluoro carbons (CFC). These gases are called green house gases.**

## IMPACTS OF GREEN HOUSE EFFECT:

### Global warming

The warming up of the earth's surface due to green house effect is termed as global warming. CO<sub>2</sub> and other green house gases present in the atmosphere trap the infrared radiation from the sun and do not allow the radiations to escape. Hence the earth's surface is warming up more and more.

### Harmful effects of global warming caused by Green house effect:

1. Evaporation process of surface water is enhanced very much due the increase in temperature of earth's surface which leads to drastic seasonal change. Some region of the world would become dry.
2. Sea level is increased due to melting of glaciers. Hence, low lying land areas will be submerged under sea water.
3. Food production is mainly affected and it leads to draught.
4. The tropical diseases like malarial fever, dengue fever and cholera will spread to the other parts of the world.
5. It causes drastic change in seasons. Hence, human beings and animals are mostly affected by climatic change.
6. Natural calamities like cyclones, hurricane, typhoons and tsunami may occur frequently and strongly.
7. Because of global warming, the normal weather pattern is disrupted. Some parts of the world will face severe water crisis while the other parts will suffer from flooding. Spring arrives earlier in many parts of the world. An early spring may disturb animal migration.
8. Biological productivity also decreases due to global warming.

### Ozone layer

One of the gifts given by nature is ozone layer. It is present about 20 km above the earth's surface. It forms a layer of about 3mm thickness called ozone layer. Oxygen is converted into ozone by photochemical change as follows.

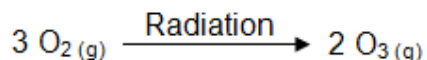

The region in which O<sub>3</sub> density high is called ozone layer.

### Importance of ozone layer

1. Ozone layer covers the earth's surface and prevents the entry of harmful UV radiation. It saves the lives of human beings and animals. If not so, no life is found on earth.
2. If the ozone layer is not present in the atmosphere, the harmful UV radiations will enter the earth. This will destroy human and animal life, change the wind pattern, rain fall, climatic change and global temperature.



### Causes for depletion of ozone layer

Chlorine plays a vital role in the depletion of ozone layer. Chloro fluoro carbons are released from the supersonic jets, air crafts and jet engines. They get accumulated at high altitude and undergo decomposition in the presence of ultraviolet radiations. Chlorine is the main decomposition product. It reacts with the ozone and converts it into oxygen.

Chlorine converts the ozone molecules into oxygen in the presence of UV radiation as follows.

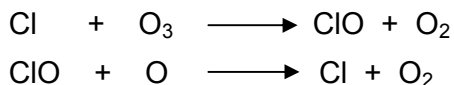

It is noteworthy that one atom of chlorine may convert huge number of molecules of ozone into oxygen. The main source for chlorine is CFC which is released by aircrafts, jet planes, refrigerators, air-conditioners, etc. **One atom of chlorine can convert about  $10^6$  molecules of ozone into oxygen.** The other gases which cause ozone layer depletion are NO and NO<sub>2</sub>.

### Harmful effects of ozone layer depletion

1. Due to ozone layer depletion, the harmful UV radiation may enter freely into the earth's surface and affect the lives on earth.
2. They affect human beings and cause skin cancer, skin aging, breast cancer, lungs cancer, eye defects and visual defects.
3. They reduce the population of aquatic species.
4. They affect the growth of plants and vegetables.
5. They affect the eco-system very badly.
6. The sea food production also decreases due to the depletion of ozone layer.
7. Depletion of ozone layer causes the change in earth's climate, wind pattern, rainfall and global warming.

### Control of air pollution

"Prevention is better than cure". Similarly, it is better to control the air pollutants at its source itself.

The following are the steps to be taken for controlling air pollution.

1. The exhaust gases from automobiles and vehicles should be minimized by the use of catalyst.
2. Tall chimneys may be used to reduce the concentration of pollutants at the ground level.
3. Smoke may be removed by Cottrell's electrostatic precipitator.

4. Dust particles can be removed by the use of bag filters and dust separators.
5. The use of coal, wood and traditional fuels should be slowly reduced. Solar energy, tidal power, nuclear power and electricity should be used for domestic and industrial purpose.
6. Acid and chemical fumes are absorbed in water, concentrated and reduced.
7. Growing of trees reduces more pollution as well as the harmful carbon dioxide concentration in the atmosphere. Plants take carbon dioxide during photosynthesis and releases oxygen to environment. Hence, more trees should be planted.

### **Summary**

In this lesson, air pollution, acid rain, green house effect, global warming, ozone layer depletion, their causes and harmful effects and methods to control the air pollution are discussed.

### **QUESTIONS**

#### **PART – A**

1. Define pollution.
2. Define air pollution.
3. Give examples for air pollutants.
4. Mention the harmful effects of  $\text{SO}_2$ .
5. Mention the harmful effects of  $\text{H}_2\text{S}$ .
6. Mention the harmful effects of HF.
7. Mention the harmful effects of CO.
8. Mention the harmful effects of dust.
9. Give examples for gases causing acid rain.
10. Give two examples for green house gases.
11. What is global warming?
12. Mention the names of pollutants responsible for depletion of ozone layer.

#### **PART – B**

1. What is acid rain?
2. Mention the harmful effects of acid rain.
3. What is green house effect?
4. Mention the harmful effects of global warming.
5. What is the importance of ozone layer?
6. Mention the harmful effects of ozone layer depletion.

#### **PART – C**

1. What are the major air pollutants? Give their source and harmful effects.

2. What is acid rain? Mention its harmful effects.
3. Write a note on green house effect.
4. What is global warming? List its harmful effects.
5. What are the causes of ozone layer depletion? List the problems caused by ozone layer depletion.
6. Write a note on control of air pollution.

### **TEST YOUR UNDERSTANDING**

Discuss the various techniques employed for the control of air pollution.

## 1.2.WATER POLLUTION

### INTRODUCTION

Water is more important for all the living things. Water is essential for the plants to grow. If the water is contaminated with any foreign substance, it is harmful to human beings, plants, animals, etc.

### Water Pollution

**Water Pollution may be defined as the excessive discharge or addition of unwanted and undesirable foreign matters into the water that causes huge damage to the life and properties of human , plants and animal.**

### Causes of water pollution

The main sources of water pollution are

1. Sewage
2. Effluents
3. Algae and
4. Microorganisms

### Sewage

**Sewage is the liquid waste of the community which includes human wastes, kitchen wastes and street washings.**

### Harmful effects of sewage

1. Hydrogen sulphide gas is produced in the sewage due to the decomposition of organic impurities which gives a bad smell.
2. Due to corrosive nature, it affects the pipelines.
3. It helps for the growth of harmful bacteria and viruses and cause many diseases like cholera, janduce, polio etc.
4. Inflammable substances like alcohol and ether may cause severe effects and fire accident.
5. The enrichment of nutrients like nitrates and phosphates in sewage water which causes the growth of aquatic plants which releases the toxic chemicals .This affects the aquatic lives.
6. The solids in it reduce the flow of water and become stagnant.
7. The aquatics like fish die due to lack of oxygen in sewage. The biological oxygen demand is reduced.
8. It also affects the nature and fertility of the soil and affects the food production.

## **Sewerage(Treatment of sewage):**

Removal of sewage by some treatment methods is called sewerage. It involves the following steps.

1. The floating impurities can be removed by mesh screens.
2. The suspended impurities can be removed by filtration and coagulation process using Alum.
3. Inflammable organic impurities can be removed by oxidation process.
4. By neutralization method, the corrosive acids and bases can be removed.
5. The bacterial impurities can be removed by chlorination.
6. The water left out from the sewage can be treated by suitable purification method and can be used for other purposes.
7. By passing oxygen the oxidisable matter is removed.
8. It is treated with lime to remove phosphorous as calcium phosphate.

## **Effluents**

**The waste water from various industries containing harmful chemicals. This Industrial waste water is known as effluent.**

### **Harmful effects of effluents**

1. It may cause severe damage to aquatic animals.
2. The metals present in the effluent may seriously affect the human organs like kidney, brain, etc.
3. It corrodes the pipelines due to acidic nature of effluents.
4. The effluents of chemical industries and nuclear power stations may affect the health of human beings and animals.
5. The effluents may enrich the acidic nature of the soil and affect the fertility of the land and growth of plants.
6. The phosphates and nitrates cause Eutrophication.
7. The metallic pollutants like Cu, Pb, Cd present in the effluents affects the health.
8. The organic impurities help the growth of disease causing microorganisms like bacteria, virus and protozoa and produces diseases like cholera, jaundice and typhoid.

### **Treatment of effluents**

1. Toxic nature of effluents may be removed by chemical methods.
2. The acidic nature and basic nature of the effluents may be removed by neutralization.
3. The radioactive effluents are carefully stored and buried under the ground.
4. The heavy metallic impurities may be removed by special methods.

### **Harmful effects of heavy metal ions present in effluents**

#### **Harmful effects of Lead**

1. Affects liver and kidney
2. Causes nervous disorder
3. Produce mental retardation in children
4. Produce gastro-intestinal damage
5. Causes loss of appetite

#### **Harmful effects of Copper**

1. Severely affect the digestive system
2. Causes vomiting and diarrhea
3. Affects blood, bone and teeth
4. It is toxic to aquatic life
5. Causes cancer and tuberculosis

#### **Harmful effects of Cadmium**

1. Causes kidney damage
2. Affects liver
3. Produce anemia and hypertension
4. Produce gastro-intestinal damage
5. Causes vomiting and diarrhea

#### **Harmful effects of Zinc**

1. Affects skin
2. Causes vomiting and diarrhea
3. Causes irritation
4. Causes dizziness and itching
5. Causes nausea

### **Harmful effects of algae**

1. Presence of algae in water produces foul odour and bad taste to water.
2. They block the pipelines and filters.
3. They affect the aquatic animals due to depletion of oxygen.

### **Treatment of algae**

1. The growth of algae can be controlled by using algaecide like copper sulphate.
2. The algae can be destroyed by using chemicals like bleaching powder, activated carbon and lime.
3. The growth of algae can also be controlled by preventing the sunlight to fall on the surface of water.

### **Harmful effects and control of microorganisms (Bacteria and viruses)**

1. They cause diseases like cholera, jaundice, typhoid, etc.
2. They are destroyed using disinfectants like bleaching powder and chlorine.

### **Eutrophication**

**The ageing of lake and pond by the enrichment of nutrients is called eutrophication.**

#### **Causes of Eutrophication**

Eutrophication is due to the mixing of sewage water water from agricultural land, domestic detergent wastes, containing nitrogen compounds and phosphates into lake water. It enhances the growth of algae.

#### **Harmful effects of eutrophication**

1. It enhances the growth of algae in water which leads to depletion of oxygen in water. Algae release the toxic chemicals. It affects the aquatic animals badly.
2. When the oxygen level falls to zero, the sulphates are reduced to H<sub>2</sub>S.
3. It produces bad taste and odour after it decays.
4. It blocks the pipelines and filters.
5. It admits the growth of bacteria and viruses. It may spread water borne disease like dysentery, cholera, Typhoid, yellow fever which affects human beings.
6. It causes an imbalance in eco-system based on water resources.
7. Population of aquatic animals is reduced.

8. Algal toxin accumulated in shell fish are harmful to human system. They produce paralysis, diarrhoea and stomach disorder.
9. Algae and other rooted weeds clog the water filters. They also cause damage to hydroelectric engine.

### **Summary**

In this lesson, water pollutants like sewage, effluents, eutrophication, their causes, problems and rectification methods are discussed.

### **QUESTIONS**

#### **PART – A**

1. Give two examples for water pollutants.
2. What is sewage?
3. What is sewerage?
4. What are industrial effluents?
5. Give the problems of lead in water.
6. Give the problems of copper in water.
7. Give the problems of cadmium in water.
8. Give the problems of zinc in water.
9. What is eutrophication?

#### **PART – B**

1. Mention any three harmful effects of sewage.
2. Write a note on sewage disposal.
3. Mention the harmful effects of effluents.
4. Mention the harmful effects of algae. How it is controlled?
5. Mention the harmful effects of microorganisms. How it is controlled?
6. Mention any three harmful effects of eutrophication.

#### **PART – C**

1. What are the major water pollutants? Give their harmful effects.
2. What is sewage? What are its harmful effects? How it is disposed?
3. What are effluents? Explain the problems and treatment of effluents.
4. Mention the harmful effects of metallic pollutants (lead, copper, cadmium and zinc) in water.
5. Define eutrophication. Mention its harmful effects.

### **TEST YOUR UNDERSTANDING**

Discuss various methods of waste water treatment.



## 1.3 SOLID WASTE MANAGEMENT

### INTRODUCTION

Annual municipal waste in India is about 280 million tons per year and is creating huge problems for the country. Hence there is an urgent need to tackle this problem.

#### **Solid waste**

Any substance that is discarded is called waste. The waste may solid, liquid or gaseous substances. The solid waste arises from human and animal activities.

Solid waste is a substance which is left over from industries, kitchen or other waste and thus thrown away. They can cause hazard to human health and environment. Hence, there is an urgent need for the management of solid waste.

**Solid waste management is the collection of wastages, transporting, processing, recycling and monitoring of the waste materials to reduce their effect on health and environment.**

#### **Types of solid waste**

Various types of solid wastes are

Sl. No.	Types	Examples
1	Commercial garbage	Bricks, cement, sand, etc.,
2	Agricultural waste	Herbicides, pesticides, crop residue, animal and poultry waste, etc.,
3	Rural waste	Bagasse, cow dung garbage, rice husk, etc.,
4	Plastic waste	Plastic toys, cosmetics, food packaging, etc.,
5	Medicinal waste	Cotton containing blood, dressing linen, syringes, waste medicines, etc.,
6	Domestic waste & e-waste	Food waste, plastics, computer, TV, broken bottle, ceramic materials, metallic containers, kitchen waste, etc.,
7	Municipal garbage	Food waste, plastics, metals, paper and paper board, etc.,
8	Industrial waste	Products of iron, cadmium, tin, lead, arsenic, mercury, radioactive materials, etc.,

#### **Problems caused by solid waste**

1. Air becomes unclean with foul smell.
2. The biomedical waste causes infectious disease and gives bad smell.
3. Human health is affected.
4. Pollutes the air, land and ground water.
5. Contaminate the environment.

6. Affects the climate.

Hence, there is an urgent need for the management of solid waste.

Solid waste management is not fully implemented because of

1. Lack of education and awareness
2. Lack of motivation
3. Resistance to change
4. Non co-operation from house holds
5. Lack of knowledge on benefits of segregation

### **Role of private sector organizations**

The private sector can play an important role in construction, operation and maintenance of treatment and disposal facility. NGO's can also play an important role in,

- i. Organizing rag-pickers/waste collectors for door-to-door collection and segregation of waste.
- ii. Creating public awareness for storage of organic and recyclable waste separately at source and handing over the waste to waste collector.

Rag-pickers could be involved in door-to-door collection of municipal solid waste as well as recyclable waste, so that they could get a user fee for collecting waste from the doorstep and derive additional income from sale of recyclables.

### **Methods of disposal of solid waste**

The waste management concepts includes 1.Reduce 2.Reuse 3.Recycle

The aim of waste management is to extract maximum benefit from the wastes and to reduce the amount of waste. The final disposal of solid wastes can be carried out by the following methods.

#### **1. Land fill**

In this method, waste is buried underground and covered with soil. Landfills were often established in abandoned areas.

Modern land fill contain a series of three dimensional control cells. The wastes dumped in the appropriate cells can be covered by a layer of soil at the end of each day. Below the wastes dumped in the cell, a double liner system is provided to prevent the leachates from polluting the soil and ground water beneath the site. The upper liner must be a well flexible membrane lining made of plastic or rubber.

A properly designed and well managed land fill can be a hygienic and relatively inexpensive method of disposing of waste materials.

Poorly designed landfills can create a number of adverse environment impacts such as wind-blown litter. Harmful gases like methane are given off from land fill sites that cause air pollution and contribute to global warming.



## 2. Incineration

Incineration is a waste treatment process that involves the combustion of solid waste at  $1000^{\circ}\text{C}$ . Waste materials are converted into ash, flue gas and heat. The ash is mostly formed by the inorganic constituents of the waste and gases due to organic waste. The heat generated by incineration can be used to generate electricity.

This process reduces the volumes of solid wastes to 20-30 percent of original volume.



Figure: Incineration plant

### Summary

In this lesson, various types of solid wastes, their problems and need for the management and methods of management are discussed.

### QUESTIONS PART – A

1. What are solid wastes? Give examples.
2. What are the two methods employed for disposal of solid waste?
3. What is landfill?
4. What is incineration?

### **PART – B**

1. Write a note on land fill.
2. Write a note on incineration.

### **PART – C**

1. List the different types of solid wastes. Explain their origination.
2. Mention the problems caused by solid waste.
3. Explain the two methods of disposal of solid waste.

### **TEST YOUR UNDERSTANDING**

1. Think of a project – How electricity can be produced from garbage?
2. Think of a project – How manure can be produced from garbage?

## 1.4 GREEN CHEMISTRY

### INTRODUCTION

The chemical industries produce a large number of products that make invaluable contribution in our daily life. It improves the quality of lives and comforts. During the manufacture of such products, the chemical industry releases enormous quantities of environmentally harmful wastes. It results in pollution. Hence, chemistry in particular, has lost some of its glamour in the public eye. One of the most attractive concepts for pollution prevention is green chemistry.

### Green chemistry

Green chemistry is defined as the design of environment friendly products and process to minimize or remove hazardous substances. **The chemistry which is used to prevent pollution is called as Green chemistry.**

Natural processes are 'green' while synthetic processes are often 'grey'. Cleaner process and cleaner synthesis will certainly contribute to better environmental protection.

### Goals of green chemistry

Some guidelines may be given while designing the products and determining the processes to achieve the goals of green chemistry.

1. To prevent the formation of waste material before it is formed.
2. It aims to minimize the global warming.
3. New methods should be developed to convert almost all the reactants used in the process into the final product.
4. To design synthetic methodologies that does not give toxic chemicals.
5. To avoid the usage of auxiliary substances (solvents) wherever possible.
6. To ensure the conduction of synthetic methods at ambient temperature and pressure.
7. To reduce the formation of byproducts which are harmful.
8. To make use of renewable materials as raw materials during the process.
9. To perform the process in a safe and controlled way.
10. To reduce the quantity of highly hazardous chemicals during the process.
11. Using the non-conventional energy like solar and wind energy.
12. The products should be recyclable.

### Recycling

**Recycling is a process of converting used materials (waste) into new useful and valuable products.**

This process is carried out to,

1. prevent wastage of potentially useful materials
2. Reduce the consumption of fresh raw materials
3. Reduce energy usage
4. Reduce air pollution and water pollution

Recycling reduces the need for “conventional” waste disposal methods and there by lower green house gas emissions. Recycling is a key component of modern waste reduction and is the third component of the “Reduce, Reuse, Recycle” waste.

Recycling refers to the collection and reuse of waste materials. Materials for recycling may be collected from general waste and reprocessed into new products.

### **Examples of recycling**

1. Used paper can be converted into new paper.
2. Used foamed polystyrene can be converted into new polystyrene.
3. Used aluminium containers can be converted into new containers.
4. Kitchen scraps can be used to make compost (Compost is an organic material that adds nutrients to soil).
5. Used glass containers can be converted into new glass containers.
6. Metal scraps can be converted into new materials.

### **Advantages of recycling**

1. It helps in the conservation of natural resources.
2. It protects the environment of the area. The recycling is eco-friendly.
3. It protects our health.
4. It makes the air clean and free from foul smell.
5. It reduces the pollution of water bodies.
6. It saves lot of energy.
7. Forests are saved by recycling the waste paper. This minimizes the global warming.

### **Summary**

In this lesson, green chemistry, goals of green chemistry, recycling, examples of recycling and its advantages are discussed.

### **QUESTIONS**

#### **PART – A**

1. Define green chemistry.
2. Give any two goals of green chemistry.
3. What is recycling?

#### **PART – B**

1. Give any three goals of green chemistry.
2. What is recycling? Give an example.

#### **PART – C**

1. Define green chemistry. Give the goals of green chemistry.
2. Explain the advantages of recycling.

### **TEST YOUR UNDERSTANDING**

Think of a project – how different materials can be recycled?

## UNIT II

### 2.1 FUELS

#### INTRODUCTION

In this present age of rapid industrial development, the power requirement is increasing day-by-day. Heat energy is the main source of power. Burning of carbon, an exothermic reaction produces heat energy. Hence, the carbon compounds have been used as the main source of heat energy.

#### Fuel

A fuel is a substance, which on proper burning gives large amount of heat energy on combustion. It is used for domestic and industrial purposes. They contain carbon as a main constituent.

#### Fossil fuel

The main sources of fuels are coal and petroleum oils available in earth's crust and they are called fossil fuels.

The other sources of fuels are

- (i) Radioactive elements and
- (ii) Sunlight

#### Calorific value of a fuel

Calorific value of a fuel is the total quantity of heat liberated when a unit mass or volume of the fuel is completely burnt.

#### Unit of heat

Heat energy is measured in terms of calorie or kilocalorie.

Calorie is the quantity of heat required to raise the temperature of 1 gram of water through 1° Centigrade (1 kcal = 1000 calories)

#### Gross calorific value

Gross calorific value of a fuel is defined as the total quantity of heat liberated when a unit mass of the fuel is completely burnt and the combustion products are cooled to room temperature

Gross calorific value = Heat of reaction + Latent heat of steam produced +  
Sensible heat obtained by cooling the combustion  
Products to room temperature

#### Net calorific value

The net calorific value of a fuel is the actual amount of heat available when unit mass of the fuel is completely burnt and combustion products are permitted to escape.

Net Calorific Value = Gross calorific value – Latent heat of water vapour formed.

## Classification of fuels

Fuels are classified into natural or primary fuels and artificial or secondary fuels. Each type is further subdivided into solid, liquid and gaseous fuels.

Sl. No.	State of fuel	Natural	Artificial
1	Solid	Wood, peat, lignite, coal	Wood charcoal, coke
2	Liquid	Crude petroleum	Kerosene, petrol, diesel, alcohol
3	Gaseous	Natural gas	Water gas, producer gas, biogas, coal gas, LPG

## Solid fuels

### Wood

It is a low-grade fuel. Freshly cut wood contains 25-50% moisture. Moisture may be reduced to 25% on air-drying. The composition of moisture free wood is C = 55%; H<sub>2</sub> = 6%; O<sub>2</sub> = 43% and ash = 1%. The calorific value of dried wood is 3500 to 4500 kcal/kg. It burns with a long and non-smoky flame. It is used as a domestic fuel.

### Coal

Coal is a natural fuel formed by the slow carbonization of vegetable matter buried under the earth some thousands of years ago. It is classified into four kinds based on the carbon content and the calorific value.

1. Peat
2. Lignite
3. Bituminous coal
4. Anthracite coal

#### 1. Peat

It is the first stage of formation of coal from wood. It is brown, fibrous jelly-like mass. It contains 80-90% moisture. The composition of peat is C = 57%; H<sub>2</sub> = 6%; O<sub>2</sub> = 35% and ash = 2.5%. The calorific value of peat is 5400 kcal/kg. It is a low-grade fuel due to high water content.

#### Uses

1. It is used as fertilizer.
2. It is used as packing material.

#### 2. Lignite

Lignite is immature form of coal. It contains 20-60% moisture. Air-dried lignite contains C = 60-70% and O<sub>2</sub> = 20%. It burns with a long smoky flame. The calorific value of lignite is 6500-7100 kcal/kg.

#### Uses

1. It is used as a domestic fuel.
2. It is used as a boiler fuel for steam production.



3. It is used in the manufacture of producer gas.

### **3. Bituminous coal**

It is a high quality fuel. Its moisture content is 4%. Its composition is C = 83%; O<sub>2</sub> = 10%; H<sub>2</sub> = 5% and N<sub>2</sub> = 2%. Its calorific value is 8500 kcal/kg.

Uses

1. It is used in metallurgy.
2. It is used in steam production.
3. It is used for making coal gas.
4. It is also used for domestic heating.

### **4. Anthracite coal**

It is the superior form of coal. It contains C = 92-98%; O<sub>2</sub> = 3%; H<sub>2</sub> = 3% and N<sub>2</sub> = 0.7%. It burns without smoke. Its calorific value is 8700 kcal/kg.

**Uses:**

1. It is used for steam production and house hold purposes.
2. It is used for direct burning in boilers and in metallurgy.
3. It is used in thermal power plant.
4. It is used in coal tar distillation.
5. It is used in glass furnaces.

## **Liquid fuels**

### **a. Petroleum**

Petroleum (Crude oil) is a naturally available liquid fuel. It is a dark greenish-brown viscous oil found deep in earth's crust. It is composed of various hydrocarbons with small amount of other organic compounds as impurities.

### **Refining of petroleum**

The process of purification and separation of various fractions present in petroleum by fractional distillation is called refining of petroleum. Refining is carried out in oil refineries.

### **Fractional distillation**

It is the process of separation of various components of a liquid mixture based on the difference in their boiling points by repeated evaporation and condensation.

### **Refining of petroleum – Process**

The crude oil is treated with copper oxide to remove sulphur impurities. Then it is repeatedly washed with sulphuric acid to remove basic impurities. It is then washed with sodium hydroxide to remove acidic impurities. Then it is

subjected to fractional distillation and various fractions are collected. The various fractions obtained and their uses are given in the table below.

**Products of fractional distillation of petroleum and their uses:**

SL. No.	Fractions	Temperature	Uses
1	Gases	Below 30°C	Used as industrial and domestic fuel
2	Petroleum ether	30°C to 80°C	Used as a solvent
3	Gasoline or petrol	40°C to 180°C	Used as a solvent, fuel and in dry cleaning
4	Kerosene oil	180°C to 250°C	Used as illuminant and fuel
5	Diesel oil or gas oil	250°C to 320°C	Used as fuel for diesel engine
6	Heavy oil or lubricating oil	320°C to 400°C	Used for lubrication, cosmetics and in medicines
7	Residue or asphalt or pitch	Above 400°C	Used for road making and water proofing of roofs

**Cracking**

**Cracking is a process by which the hydrocarbons of high molecular mass are decomposed into hydrocarbons of low molecular mass by heating in the presence or absence of a catalyst.** Generally aluminum silicates are used as catalyst.

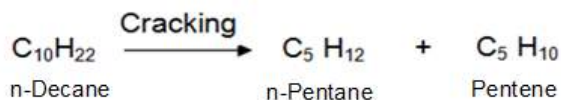

**b. Liquid hydrogen as a fuel**

Hydrogen is a colourless and odourless gas composed of diatomic molecules. It holds greater role as fuel in future.

Liquid hydrogen is a favourable rocket fuel. On combustion, it produces more heat per gram than any other fuel. Further, it produces only water on combustion whereas the fossil fuels produce gases like SO<sub>2</sub>, NO<sub>2</sub> and CO<sub>2</sub> causing environmental pollution. Hence, hydrogen as a fuel has more advantages than any other fossil fuels.

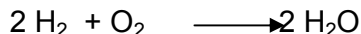

Hydrogen is not a primary fuel. It is obtained from other sources of energy. It can be obtained directly from water by decomposing with some energy source. Solar photovoltaic collectors are used to decompose water by electrolysis.

Hydrogen can be liquefied below its temperature of 33.1K. It is a colourless, odourless liquid below 20.2 K. When allowed to expand, it gets heated up above 22 K.

## Gaseous fuels

Examples: Producer gas, water gas, CNG and LPG

### Producer gas

Producer gas is a mixture of carbon monoxide and nitrogen. It also contains traces of hydrogen and carbon dioxide.

The average composition of producer gas is CO = 22-30%; H<sub>2</sub> = 8-12%; N<sub>2</sub> = 52-55% and CO<sub>2</sub> = 3%. Its calorific value is about 1300 kcal/m<sup>3</sup>.

### Preparation

Producer gas is prepared by passing air over a red hot coke at about 1100°C in a reactor called gas producer.

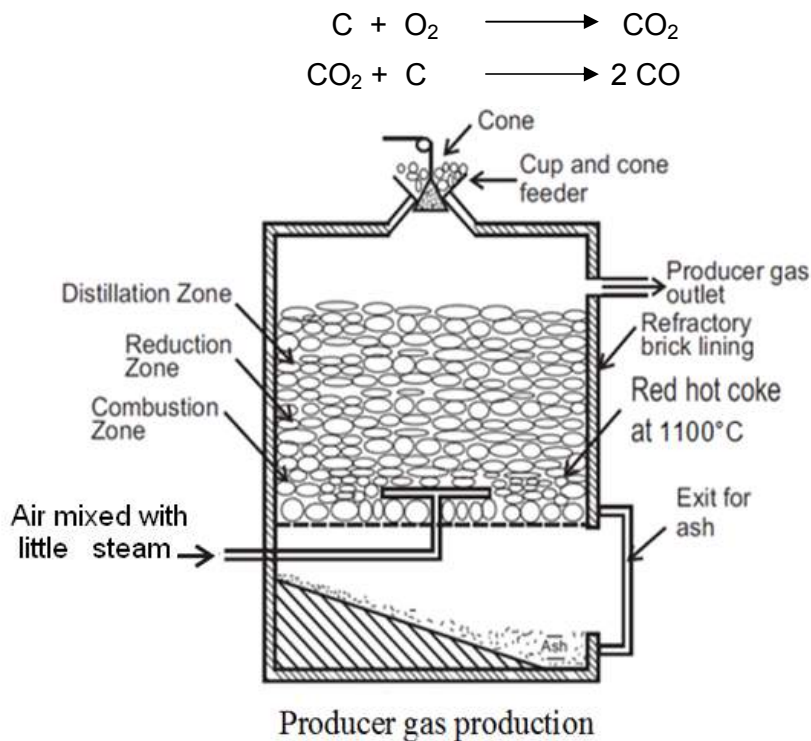

The reactor consists of a steel vessel lined inside with refractory bricks. At the top, it is provided with cup and cone arrangement and an exit for producer gas. At the bottom, it has an inlet for passing air. There is an exit for the ash at the base.

### Uses

1. It is used as a fuel in the extraction of metal.
2. It is used in the manufacture of glass.
3. It is used as a reducing agent in metallurgy.

### Water gas

Water gas is a mixture of carbon monoxide and hydrogen. It also contains traces of carbon dioxide and nitrogen.

The average composition of water gas is  $\text{CO} = 41\%$ ;  $\text{H}_2 = 51\%$ ;  $\text{N}_2 = 4\%$  and  $\text{CO}_2 = 4\%$ . Its calorific value is  $2800 \text{ kcal/m}^3$ .

### Preparation

Water gas is prepared by passing steam and little air alternatively over a red hot coke at about  $1000^\circ\text{C}$  in a reactor. It is an endothermic reaction. So the temperature of the system decreases.

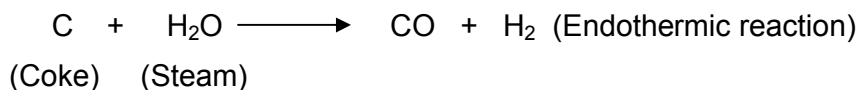

But, the reaction between carbon and air is exothermic and raises the temperature to about  $1000^\circ\text{C}$

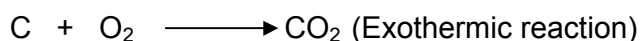

Thus, the steam and air are sent in alternatively to maintain the temperature at about  $1000^\circ\text{C}$ .

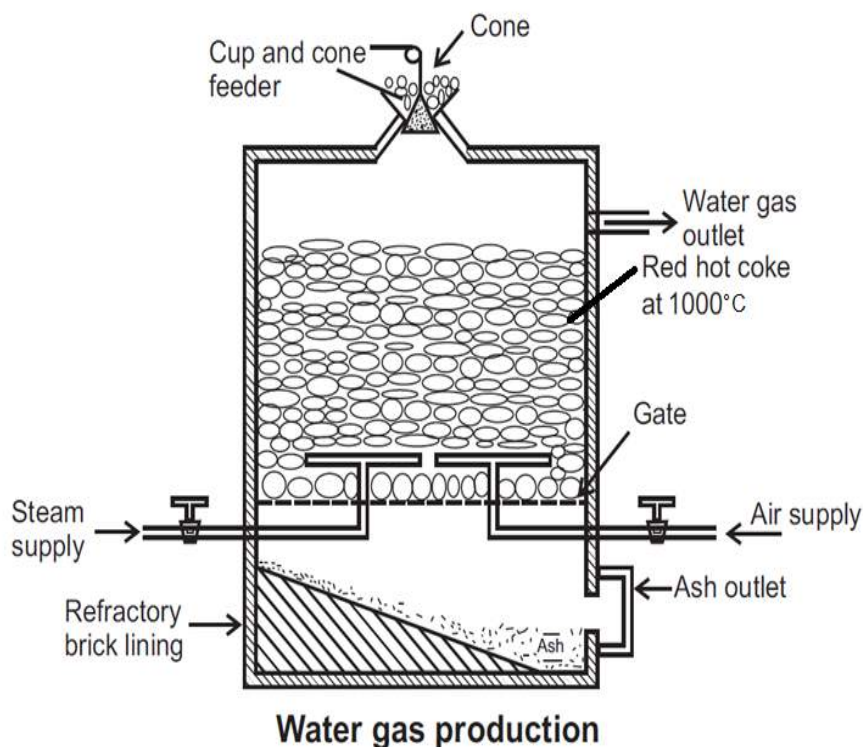

The reactor consists of a steel vessel lined inside with refractory bricks. At the top, it has cup and cone feeder and an exit for water gas. At the base, inlet pipes for steam and air are provided. At the bottom, outlet for ash is also available.

### Uses

1. It is used as a source of hydrogen gas.
2. It is used as an illuminating gas.
3. It is used as a fuel in ceramic industries.

### **CNG (Compressed natural gas)**

CNG is a good alternative fossil fuel. It mainly contains methane. CNG is made by compressing natural gas which is found in oil deposits, landfills and waste water treatment plants to less than 1% of its volume, it occupies at standard atmospheric pressure. It is stored and distributed in hard containers at a pressure of 2900-3600 psi.

#### **Advantages**

1. It is cheaper than petrol or diesel.
2. It emits fewer pollutants like CO<sub>2</sub>, CO, etc. In New Delhi, it is used as a fuel for entire city bus fleet, taxis and three wheelers.
3. It is safer than other fuels. In the event of a spill, it disperses quickly in air because, it is lighter than air.

#### **LPG (Liquefied petroleum gas)**

1. It is a mixture of propane and butane.
2. It is stored in steel cylinder under high pressure.
3. When the cylinder is opened, it comes out in the form of gas.
4. Commercially, it is supplied under various trade names.
5. Its calorific value is 27,800 kcal/m<sup>3</sup>.

#### **Uses**

1. It is mainly used as a domestic fuel.
2. It is used as a fuel in diesel engines.
3. It is used as a motor fuel.

#### **Relative advantages of solid, liquid and gaseous fuels**

Sl. No.	Property	Solid fuel	Liquid fuel	Gaseous fuel
1	Calorific value	Low	Greater than solid fuel and less than gaseous fuel	Very high
2	Smoke production	High	Low	Nil
3	Ash formation	Ash produced	Very low	Nil
4	Storage	Large space needed	Less space needed	Minimum space needed
5	Transportation	More labour involved	Much less labour involved	Transported easily through pipelines
6	Ignition	Difficult	Easy	Very easy
7	Flame control	Difficult	Easy	Very easy

## Summary

In this lesson, different types of fuels, their composition and uses are discussed. The manufacture, composition and uses of producer gas, water gas and some details about CNG and LPG are also discussed.

### QUESTIONS

#### PART – A

1. Define fuel.
2. Define fossil fuel.
3. Define calorific value of a fuel.
4. How are fuels classified?
5. Give two examples for solid fuels.
6. Give two examples for liquid fuels.
7. Give two examples for gaseous fuels.
8. What are the varieties of coal?
9. What is petroleum?
10. What is meant by cracking?
11. What is producer gas?
12. Give the composition of producer gas.
13. What is water gas?
14. Give the composition of water gas.
15. What are the components present in CNG?
16. Mention the uses of CNG.
17. What are the components present in LPG?
18. Mention the uses of LPG.

#### PART – B

1. What is refining of petroleum?
2. Write a note on liquid hydrogen as fuel.
3. Give the composition and uses of producer gas.
4. Give the composition and uses of water gas.
5. Give the composition and uses of CNG.
6. Give the composition and uses of LPG.

#### PART – C

1. Write a note on solid fuels.
2. Explain the fractional distillation of petroleum.
3. Describe the manufacture of producer gas. List its uses.
4. Describe the manufacture of water gas. List its uses.
5. Write a note on CNG.
6. Write a note on LPG.
7. Compare the relative advantages of solid, liquid and gaseous fuels.

### TEST YOUR UNDERSTANDING

Think of how household waste can be utilized to produce gaseous fuel.

## 2.2 COMBUSTION

### INTRODUCTION

Combustion is an exothermic chemical reaction accompanied by heat and light. To ensure complete combustion, substance should be brought to its ignition temperature. Most of the combustible substances are enriched with carbon, hydrogen and sulphur. During combustion they undergo thermal decomposition and oxidation to give products like CO<sub>2</sub>, H<sub>2</sub>O and SO<sub>2</sub> etc.

Hence for an efficient combustion it is essential that the fuel must contact with sufficient quantity of air. The air contains oxygen which is used for combustion. But the non-combustible constituents like N<sub>2</sub>, CO<sub>2</sub>, and H<sub>2</sub>O do not take any oxygen from air.

Incomplete combustion occurs only when there is too little air or oxygen is supplied. During incomplete combustion the carbon monoxide is formed instead of CO<sub>2</sub>.

### Ignition temperature:

The minimum temperature at which a fuel catches fire and burns is called ignition temperature.

### Definition:

**The chemical reaction of a fuel with oxygen(oxidising agent) which produces heat and light energy is called combustion of a fuel.**

Example: Combustion of carbon

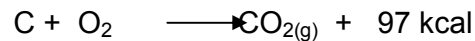

The gaseous products of combustion are mainly CO, CO<sub>2</sub>, N<sub>2</sub>, SO<sub>2</sub>, O<sub>2</sub> and H<sub>2</sub>O which are known as flue gases. The main elements present in most of the fuels are carbon (C), hydrogen (H), oxygen (O) and sulphur (S).

Air contains 23% by mass of oxygen and 21% by volume of oxygen.

### Combustion calculation by mass (for solids and liquids):

#### **Stoichiometric or minimum quantity of air required for the complete combustion of solid and liquid fuels**

Substances always combine in definite proportions which are determined by the molecular masses of the substances involved and the products formed.

#### **1. Combustion of Carbon**

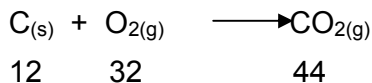

12 kg of carbon requires 32 kg of oxygen for complete combustion

$$\therefore \left. \begin{array}{l} \text{The given carbon in the fuel requires} \\ \text{oxygen for complete combustion} \end{array} \right\} = \frac{32}{12} \times C \text{ kg}$$

$$\therefore \left. \begin{array}{l} \text{For } C \text{ Kg carbon in the fuel requires} \\ \text{oxygen for complete combustion} \end{array} \right\} = \frac{8}{3} \times C \text{ kg} \quad \text{--- (1)}$$

## 2. Combustion of Hydrogen

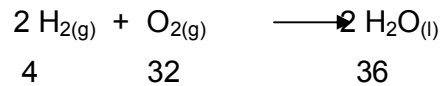

4 kg of hydrogen requires 32 kg of oxygen for complete combustion

$$\therefore \left. \begin{array}{l} \text{The given hydrogen in the fuel requires} \\ \text{oxygen for complete combustion} \end{array} \right\} = \frac{32}{4} \times H \text{ kg}$$

$$\begin{aligned} \therefore \left. \begin{array}{l} \text{For } H \text{ Kg of hydrogen in the fuel requires} \\ \text{oxygen for complete combustion} \end{array} \right\} &= 8H \text{ kg} \\ &= 8 H \text{ Kg} \longrightarrow 2 \end{aligned}$$

Combined hydrogen in fuel present as moisture (H<sub>2</sub>O) does not undergo combustion. The rest of hydrogen only takes part in the combustion reaction.

## 3. Combustion of Sulphur

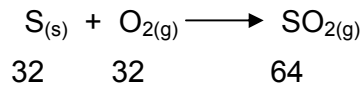

32 kg of sulphur requires 32 kg of oxygen for complete combustion

$$\therefore \left. \begin{array}{l} \text{The given sulphur in the fuel requires} \\ \text{oxygen for complete combustion} \end{array} \right\} = \frac{32}{32} \times S \text{ kg} \quad \text{--- (3)}$$

$$= S \text{ kg}$$

On combining the above three equations,

Let us assume that 1 Kg of fuel contains 'C' Kg of carbon, H Kg of hydrogen and S Kg of sulphur. Then the total mass of oxygen required for the complete combustion of 1 Kg of fuel is given below:

$$\left. \begin{array}{l} \text{The theoretical oxygen required for} \\ \text{combustion of 1 Kg of fuel} \end{array} \right\} = \frac{8}{3} \times C + 8H + S \text{ Kg}$$

'C' = Wt. of carbon; H = Wt. of hydrogen; S = Wt. of sulphur



∴ Minimum mass of oxygen is calculated on the basis of complete combustion. **Note. If the fuel already has some amount of oxygen, then that amount of oxygen has to be deducted from the total mass**

Minimum mass of oxygen required = Theoretical O<sub>2</sub> required – O<sub>2</sub> present in fuel

$$\left. \begin{array}{l} \text{ie., The total mass of oxygen} \\ \text{required per Kg of fuel} \end{array} \right\} = \left[ \frac{8}{3} \times C + 8H + S \right] - O_2$$

('O'<sub>2</sub> = Mass of oxygen)

### Mass percentage of oxygen

The mass percentage of oxygen in air = 23%

23% of Oxygen is supplied by 100 % Mass of air supply

That is to supply 23 Kg of oxygen = 100 kg of air required

Hence, one kg of oxygen is supplied by =  $\frac{100}{23}$  kg of air

Hence the mass of air that is required for combustion of 1 Kg of fuel is

$$\text{Minimum mass of air required for combustion of 1 kg of fuel} = \left[ \left[ \frac{8}{3} \times C + 8H + S \right] - O_2 \right] \times \frac{100}{23} \text{ Kg}$$

Where C, H, O and S are the respective masses of carbon, hydrogen, oxygen and sulphur present in 1 kg of the fuel.

### **Examples:**

#### **Example 1**

A fuel contains 90% carbon, 3.5% hydrogen, 3% oxygen and 0.5% sulphur. Determine stoichiometric mass of air required to completely burn 1 kg of this fuel.

$$C = 90\% = 0.9 \text{ kg}$$

$$H = 3.5\% = 0.035 \text{ kg}$$

$$O = 3\% = 0.03 \text{ kg}$$

$$S = 0.5\% = 0.005 \text{ kg}$$

1. Combustion of carbon

$$\therefore \left. \begin{array}{l} \text{For } C \text{ Kg carbon in the fuel requires} \\ \text{oxygen for complete combustion} \end{array} \right\} = \frac{8}{3} \times C \text{ kg}$$

For 0.9 kg of C requires oxygen for complete combustion

$$= \frac{8}{3} \times 0.9$$

$$= 2.4 \text{ kg}$$

2. Combustion of hydrogen

$$\therefore \left. \begin{array}{l} \text{For } H \text{ Kg of hydrogen in the fuel requires} \\ \text{oxygen for complete combustion} \end{array} \right\} = 8H \text{ kg}$$

\(\therefore\) 0.035 kg of hydrogen requires oxygen for complete combustion

$$= 8H$$

$$= 8 \times 0.035 = 0.28 \text{ kg}$$

3. Combustion of Sulphur

$$\therefore \left. \begin{array}{l} \text{The given sulphur in the fuel requires} \\ \text{oxygen for complete combustion} \end{array} \right\} = \frac{32}{32} \times S \text{ kg}$$

$$= S \text{ kg}$$

\(\therefore\) 0.005 kg of sulphur requires oxygen for complete combustion =  $\frac{32}{32} \times 0.005$

$$= 0.005 \text{ kg}$$

$$\left. \begin{array}{l} \text{Minimum mass of oxygen required for} \\ \text{complete combustion of 1 kg of the fuel} \\ \text{(Theoretical } O_2 \text{ required)} \end{array} \right\} = 2.4 + 0.28 + 0.005$$

$$= 2.685 \text{ kg}$$

Minimum mass of oxygen required = Theoretical  $O_2$  required –  $O_2$  present in fuel

$$= 2.685 - 0.03$$

$$= 2.655 \text{ kg}$$

$$\left. \begin{array}{l} \text{Minimum mass of air required for} \\ \text{complete combustion of 1 kg of the fuel} \end{array} \right\} = \frac{100}{23} \times 2.655$$

$$= 11.54 \text{ kg}$$

### Example 2:

Calculate the minimum mass of air required for complete combustion of 1 kg of a fuel having the composition C = 92%,  $H_2$  = 4%,  $O_2$  = 2% and ash = 2% by weight.

$$C = 92\% = 0.92 \text{ kg}$$

$$H_2 = 04\% = 0.04 \text{ kg}$$

$$O_2 = 02\% = 0.02 \text{ kg}$$

1. Combustion of carbon

$$\therefore \left. \begin{array}{l} \text{For } C \text{ Kg carbon in the fuel requires} \\ \text{oxygen for complete combustion} \end{array} \right\} = \frac{8}{3} \times C \text{ kg}$$

$$\therefore 0.92 \text{ kg of C requires oxygen for complete combustion} = \frac{8}{3} \times C \text{ kg}$$

$$= \frac{8}{3} \times 0.92 \text{ kg}$$

$$= 2.45 \text{ kg}$$

2. Combustion of hydrogen

$$\therefore \left. \begin{array}{l} \text{For } H \text{ Kg of hydrogen in the fuel requires} \\ \text{oxygen for complete combustion} \end{array} \right\} = 8XH \text{ kg}$$

For 0.04 kg of hydrogen requires oxygen for complete combustion

$$= 8 \times 0.04$$

$$= 0.32$$

$$= 0.32 \text{ kg}$$

$$\left. \begin{array}{l} \text{Minimum mass of oxygen required for} \\ \text{complete combustion of 1 kg of the fuel} \\ \text{(Theoretical } O_2 \text{ required)} \end{array} \right\} = 2.45 + 0.32$$

$$= 2.77 \text{ kg}$$

Minimum mass of oxygen required = Theoretical  $O_2$  required –  $O_2$  present in fuel

$$= 2.77 - 0.02$$

$$= 2.75 \text{ kg}$$

$$\left. \begin{array}{l} \text{Minimum mass of air required for} \\ \text{complete combustion of 1 kg of the fuel} \end{array} \right\} = \frac{100}{23} \times 2.75$$

$$= 11.96 \text{ kg}$$

**Example 3:**

Calculate the minimum amount of air by mass required for complete combustion of 2 kg of coke assuming 100% carbon.

$$\therefore \left. \begin{array}{l} \text{For } C \text{ Kg carbon in the fuel requires} \\ \text{oxygen for complete combustion} \end{array} \right\} = \frac{8}{3} \times C \text{ kg}$$

$$\begin{aligned} \text{Mass of O}_2 \text{ required for combustion of 2 kg of coke} &= \frac{8}{3} \times 2 \text{ kg} \\ &= 5.33 \text{ kg} \end{aligned}$$

$$\begin{aligned} \left. \begin{array}{l} \text{Minimum mass of air required for} \\ \text{combustion of 2 kg of coke} \end{array} \right\} &= \frac{100}{23} \times 5.33 \\ &= 23.17 \text{ kg} \end{aligned}$$

### Excess air

During combustion, there is an incomplete combustion, when stoichiometric air is supplied. In practice, excess amount of air is supplied to get complete combustion. To avoid cooling effect, about 25% to 50% preheated air is supplied.

Total mass of air/kg of fuel = Stoichiometric mass of air + Excess mass of air

Let the theoretical minimum air supplied = Y Kg

Let the Air supplied in excess is = 50%

$$\text{Excess air supplied} = \frac{150}{100}$$

$$\begin{aligned} \left. \begin{array}{l} \text{Then the actual amount of air supplied} \\ \text{per Kg of the fuel including the excess} \\ \text{air} \end{array} \right\} &= Y \times \left\{ \frac{100+50}{100} \right\} \\ \left. \begin{array}{l} \text{Minimum mass of air required for} \\ \text{complete combustion of 1 kg of the fuel} \end{array} \right\} &= Y \times \frac{150}{100} \\ &= Y \times 1.5 \text{ Kg of air} \end{aligned}$$

### Example 4

Calculate the mass of air to be supplied for the combustion of 1 kg of a fuel containing 75% carbon, 8% hydrogen and 3% oxygen, if 40% excess air is supplied.

$$C = 75\% = 0.75 \text{ kg}$$

$$H = 8\% = 0.08 \text{ kg}$$

$$O = 3\% = 0.03 \text{ kg}$$

1. Combustion of carbon

$$\therefore \left. \begin{array}{l} \text{For C Kg carbon in the fuel requires} \\ \text{oxygen for complete combustion} \end{array} \right\} = \frac{8}{3} \times C \text{ kg}$$

$$\begin{aligned} \therefore 0.75 \text{ kg of C requires oxygen for complete combustion} \\ = \frac{8}{3} \times 0.75 \text{ kg} \end{aligned}$$

$$= 2 \text{ kg}$$

2. Combustion of hydrogen

$$\therefore \left. \begin{array}{l} \text{For H Kg of hydrogen in the fuel requires} \\ \text{oxygen for complete combustion} \end{array} \right\} = 8XH \text{ kg}$$

0.08 kg of hydrogen requires oxygen for complete combustion

$$= 8 H$$

$$= 8 \times 0.08$$

$$= 0.64 \text{ kg}$$

$$\left. \begin{array}{l} \text{Minimum mass of oxygen required for} \\ \text{complete combustion of 1 kg of the fuel} \\ \text{(Theoretical O}_2 \text{ required)} \end{array} \right\} = 2 + 0.64$$

$$= 2.64 \text{ kg}$$

Minimum mass of oxygen required = Theoretical O<sub>2</sub> required – O<sub>2</sub> present in fuel

$$= 2.64 - 0.03$$

$$= 2.61 \text{ kg}$$

$$\left. \begin{array}{l} \text{Minimum mass of air required for} \\ \text{complete combustion of 1 kg of the fuel} \end{array} \right\} = \frac{100}{23} \times 2.61$$

$$= 11.35 \text{ kg}$$

Excess air supplied = 40%

$$\left. \begin{array}{l} \text{Minimum mass of air required for} \\ \text{complete combustion of 1 kg of the fuel} \end{array} \right\} = 11.35 \times \frac{140}{100}$$

$$= 15.89 \text{ kg}$$

**Combustion calculation by volume(for gaseous fuels):**

**Stoichiometric or minimum volume of air required for the complete combustion of 1 m<sup>3</sup> gaseous fuels**

The volume of air required for the combustion of gaseous fuels is calculated mainly based on the balanced combustion equation.

**1. Combustion of carbon monoxide**

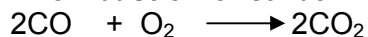

$$2 \text{ vol} \quad 1 \text{ vol} \quad 1 \text{ vol}$$

2m<sup>3</sup> of CO needs 1m<sup>3</sup> of oxygen

Therefore;

**1 m<sup>3</sup> of CO needs 0.5 m<sup>3</sup> of O<sub>2</sub> for combustion**

## 2. Combustion of hydrogen

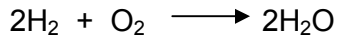

2 vol    1 vol        1 vol

2m<sup>3</sup> of Hydrogen needs 1m<sup>3</sup> of oxygen

Hence;

**1 m<sup>3</sup> of H<sub>2</sub> needs 0.5 m<sup>3</sup> of O<sub>2</sub> for combustion**

## 3. Combustion of methane

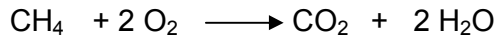

1 vol    2 vol        1 vol    2 vol

**1 m<sup>3</sup> of CH<sub>4</sub> needs 2 m<sup>3</sup> of O<sub>2</sub> for combustion**

## 4. Combustion of ethane

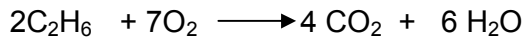

2 vol    7 vol        4 vol    6 vol

2m<sup>3</sup> of ethane needs 7 m<sup>3</sup> of oxygen

Hence;

**1 m<sup>3</sup> of C<sub>2</sub>H<sub>6</sub> needs 3.5 m<sup>3</sup> of O<sub>2</sub> for combustion**

## 5. Combustion of ethylene



**1 m<sup>3</sup> of C<sub>2</sub>H<sub>4</sub> needs 3m<sup>3</sup> of O<sub>2</sub> for combustion**

### Calculation of minimum volume of air required:

The minimum volume of air required is calculated by multiplying the oxygen required by 100/21 since the percentage volume of air is 21%.

### Example 1

Determine the volume of air needed for complete combustion of one cubic meter of producer gas having the following composition by volume.

H<sub>2</sub> = 30%, CO = 12%, CH<sub>4</sub> = 5% and N<sub>2</sub> = 50%.

$$\text{H}_2 = 30\% = 0.3 \text{ m}^3$$

$$\text{CO} = 12\% = 0.12 \text{ m}^3$$

$$\text{CH}_4 = 05\% = 0.05 \text{ m}^3$$

### 1. Combustion of hydrogen

**1 m<sup>3</sup> of H<sub>2</sub> needs 0.5 m<sup>3</sup> of O<sub>2</sub> for combustion**

$$\begin{aligned}\therefore 0.3 \text{ m}^3 \text{ of H}_2 \text{ requires oxygen for complete combustion} &= \frac{0.5}{1} \times 0.3 \\ &= 0.15 \text{ m}^3\end{aligned}$$

### 2. Combustion of carbon monoxide

**1 m<sup>3</sup> of CO needs 0.5 m<sup>3</sup> of O<sub>2</sub> for combustion**

$$\begin{aligned}\therefore 0.12 \text{ m}^3 \text{ of CO requires oxygen for complete combustion} &= \frac{0.5}{1} \times 0.12 \\ &= 0.06 \text{ m}^3\end{aligned}$$

### 3. Combustion of methane

**1 m<sup>3</sup> of CH<sub>4</sub> needs 2 m<sup>3</sup> of O<sub>2</sub> for combustion**

$$\begin{aligned}0.05 \text{ m}^3 \text{ of CH}_4 \text{ requires oxygen for complete combustion} &= \frac{2}{1} \times 0.05 \\ &= 0.1 \text{ m}^3\end{aligned}$$

$$\begin{aligned}\text{Volume of oxygen needed for} \\ \text{complete combustion of 1 m}^3 \text{ of gas} \} &= 0.15 + 0.06 + 0.1 \\ &= 0.31 \text{ m}^3\end{aligned}$$

$$\begin{aligned}\text{Minimum volume of air required} \\ \text{for combustion of 1 m}^3 \text{ of gas} \} &= \frac{100}{21} \times 0.31 \\ &= 1.48 \text{ m}^3\end{aligned}$$

### Example 2

A fuel contains 45% of H<sub>2</sub>, 40% CO, 12% CH<sub>4</sub> and 3% O<sub>2</sub> by volume. Determine volume of air required to burn 1 m<sup>3</sup> of this fuel.

$$\text{H}_2 = 45\% = 0.45 \text{ m}^3$$

$$\text{CO} = 40\% = 0.4 \text{ m}^3$$

$$\text{CH}_4 = 12\% = 0.12 \text{ m}^3$$

$$O_2 = 03\% = 0.03 \text{ m}^3$$

### 1. Combustion of hydrogen

**1 m<sup>3</sup> of H<sub>2</sub> needs 0.5 m<sup>3</sup> of O<sub>2</sub> for combustion**

Hence;

$$\begin{aligned} \therefore 0.45 \text{ m}^3 \text{ of H}_2 \text{ requires oxygen for complete combustion} &= \frac{0.5}{1} \times 0.45 \\ &= 0.225 \text{ m}^3 \end{aligned}$$

### 2. Combustion of carbon monoxide

**1 m<sup>3</sup> of CO needs 0.5 m<sup>3</sup> of O<sub>2</sub> for combustion**

$$\begin{aligned} \therefore 0.4 \text{ m}^3 \text{ of CO requires oxygen for complete combustion} &= \frac{0.5}{1} \times 0.4 \\ &= 0.20 \text{ m}^3 \end{aligned}$$

### 3. Combustion of methane

1 m<sup>3</sup> of CH<sub>4</sub> needs 2 m<sup>3</sup> of O<sub>2</sub> for combustion

$$\begin{aligned} \therefore 0.12 \text{ m}^3 \text{ of CH}_4 \text{ requires oxygen for complete combustion} &= \frac{2}{1} \times 0.12 \\ &= 0.24 \text{ m}^3 \end{aligned}$$

Volume of oxygen needed for complete combustion of 1 m<sup>3</sup> of gas } = 0.225 + 0.20 + 0.24  
(Theoretical O<sub>2</sub> required)

$$= 0.665 \text{ m}^3 \text{ O}_2$$

Minimum volume of oxygen required = Theoretical O<sub>2</sub> required - O<sub>2</sub> present in fuel.

$$= 0.665 - 0.03$$

$$= 0.635 \text{ m}^3$$

Minimum volume of air required for combustion of 1 m<sup>3</sup> of gas } =  $\frac{100}{21} \times 0.635$

$$= 3.023 \text{ m}^3 \text{ of air}$$



### Example 3

Volumetric analysis of producer gas supplied to a engine is,

H<sub>2</sub> = 20%, CO = 22%, CH<sub>4</sub> = 3%, CO<sub>2</sub> = 8% and N<sub>2</sub> = 47%

Excess air supplied is 50%. Estimate the volume of air required for combustion of 1 m<sup>3</sup> of gas.

$$\text{H}_2 = 20\% = 0.2 \text{ m}^3$$

$$\text{CO} = 22\% = 0.22 \text{ m}^3$$

$$\text{CH}_4 = 3\% = 0.03 \text{ m}^3$$

1. Combustion of hydrogen

**1 m<sup>3</sup> of H<sub>2</sub> needs 0.5 m<sup>3</sup> of O<sub>2</sub> for combustion**

$$\begin{aligned} \therefore 0.2 \text{ m}^3 \text{ of H}_2 \text{ requires oxygen for complete combustion} &= \frac{0.5}{1} \times 0.2 \\ &= 0.1 \text{ m}^3 \end{aligned}$$

2. Combustion of carbon monoxide

**1 m<sup>3</sup> of CO needs 0.5 m<sup>3</sup> of O<sub>2</sub> for combustion**

$$\begin{aligned} \therefore 0.22 \text{ m}^3 \text{ of CO requires oxygen for complete combustion} &= \frac{0.5}{1} \times 0.22 \\ &= 0.11 \text{ m}^3 \end{aligned}$$

3. Combustion of methane

**1 m<sup>3</sup> of CH<sub>4</sub> needs 2 m<sup>3</sup> of O<sub>2</sub> for combustion**

$$\begin{aligned} \therefore 0.03 \text{ m}^3 \text{ of CH}_4 \text{ requires oxygen for complete combustion} &= \frac{2}{1} \times 0.03 \\ &= 0.06 \text{ m}^3 \end{aligned}$$

$$\begin{aligned} \left. \begin{array}{l} \text{Volume of oxygen needed for} \\ \text{complete combustion of 1 m}^3 \text{ of gas} \end{array} \right\} &= 0.1 + 0.11 + 0.06 \\ &= 0.27 \text{ m}^3 \end{aligned}$$

$$\begin{aligned} \left. \begin{array}{l} \text{Minimum volume of air required} \\ \text{for combustion of 1 m}^3 \text{ of gas} \end{array} \right\} &= \frac{100}{21} \times 0.27 \\ &= 1.28 \text{ m}^3 \end{aligned}$$

Excess air supplied = 50%

$$\begin{aligned} \therefore \text{Minimum volume of air required} \} &= 1.28 \times \frac{150}{100} \\ \text{for combustion of 1 m}^3 \text{ of gas} & \\ &= 1.92 \text{ m}^3 \end{aligned}$$

**Problem:4**

A gas has the following % composition by volume CH<sub>4</sub>=4%, CO=22%.H<sub>2</sub>=14%.CO<sub>2</sub>=6% N<sub>2</sub>=52% and O<sub>2</sub>=3%.

$$\text{H}_2 = 14\% = 0.14 \text{ m}^3$$

$$\text{CO} = 22\% = 0.22 \text{ m}^3$$

$$\text{CH}_4 = 4\% = 0.04 \text{ m}^3$$

1. Combustion of hydrogen

**1 m<sup>3</sup> of H<sub>2</sub> needs 0.5 m<sup>3</sup> of O<sub>2</sub> for combustion**

∴ 0.2 m<sup>3</sup> of H<sub>2</sub> requires oxygen for complete combustion

$$= \frac{0.5}{1} \times 0.14$$

$$= 0.700 \text{ m}^3$$

2. Combustion of carbon monoxide

**1 m<sup>3</sup> of CO needs 0.5 m<sup>3</sup> of O<sub>2</sub> for combustion**

∴ 0.22m<sup>3</sup> of CO requires oxygen for complete combustion = =  $\frac{0.5}{1} \times 0.22$

$$= 0.11 \text{ m}^3$$

3. Combustion of methane

**1 m<sup>3</sup> of CH<sub>4</sub> needs 2 m<sup>3</sup> of O<sub>2</sub> for combustion**

∴ 0.03 m<sup>3</sup> of CH<sub>4</sub> requires oxygen for complete combustion

$$= \frac{2}{1} \times 0.04$$

$$= 0.08$$

$$\begin{aligned} &= 0.08 \text{ m}^3 \\ \left. \begin{array}{l} \text{Volume of oxygen needed for} \\ \text{complete combustion of 1 m}^3 \text{ of gas} \end{array} \right\} &= 0.07 + 0.11 + 0.08 \\ &= 0.26 \text{ m}^3 \end{aligned}$$

Oxygen already in the fuel = 0.02

Total volume of oxygen required for the complete combustion is = 0.26 - 0.02  
= 0.24 m<sup>3</sup>

$$\begin{aligned} \left. \begin{array}{l} \text{Minimum volume of air required} \\ \text{for combustion of 1 m}^3 \text{ of gas} \end{array} \right\} &= 0.24 \times \frac{100}{21} \\ &= 1.148 \text{ m}^3 \text{ AIR} \end{aligned}$$

### Flue gas

**Flue gas is a mixture of gases produced from the products of combustion of a fuel. Its major constituents are CO, CO<sub>2</sub>, O<sub>2</sub> and N<sub>2</sub>.**

The efficiency of combustion can be understood by quantitative analysis of flue gas. Usually, excess oxygen in the flue gas suggests that excess of air is supplied for combustion. More carbon monoxide content, suggests, incomplete combustion process. Based on flue gas analysis, improvement in the design of internal combustion engines, combustion chamber, furnace, etc., can be done.

### Flue gas analysis by Orsat's apparatus

Mainly, the flue gases CO, CO<sub>2</sub> and O<sub>2</sub> are quantitatively analysed by Orsat's apparatus.

The apparatus consists of a graduated burette (100 ml) surrounded by water, for maintaining constant temperature. One end of burette is connected to a levelling bottle through a rubber tube. The levelling bottles contain saturated NaCl solution which does not absorb any flue gases. By raising and lowering the levelling bottle, the volume of gases present in it are made to overflow and have close contact with three absorption pipette solutions.

The absorption pipettes have solution for absorption of CO<sub>2</sub>, O<sub>2</sub> and CO respectively. The first pipette is filled upto the mark with standard KOH solution to absorb CO<sub>2</sub>. The second pipette is filled with standard alkaline pyrogallol solution. This solution absorbs CO<sub>2</sub> and O<sub>2</sub>. The third pipette is filled with standard ammoniacal cuprous chloride. This solution absorbs CO<sub>2</sub>, O<sub>2</sub> and CO. Hence, it is necessary to pass the flue gas first through standard KOH solution and then through standard alkaline pyrogallol solution and finally through standard ammoniacal CuCl<sub>2</sub> solution.

To flush out the air in the apparatus, the three way stop clock is opened to the flue gas supply after closing the entries of absorption pipettes. By lowering the levelling bottle, the flue gas is admitted in the burette and the three way stop clock is opened to the flue gas supply after closing the absorption pipettes. Now, the levelling bottle is raised and the gas-air mixture

is pushed out into the atmosphere. The procedure is repeated until the pure flue gas occupies the apparatus.

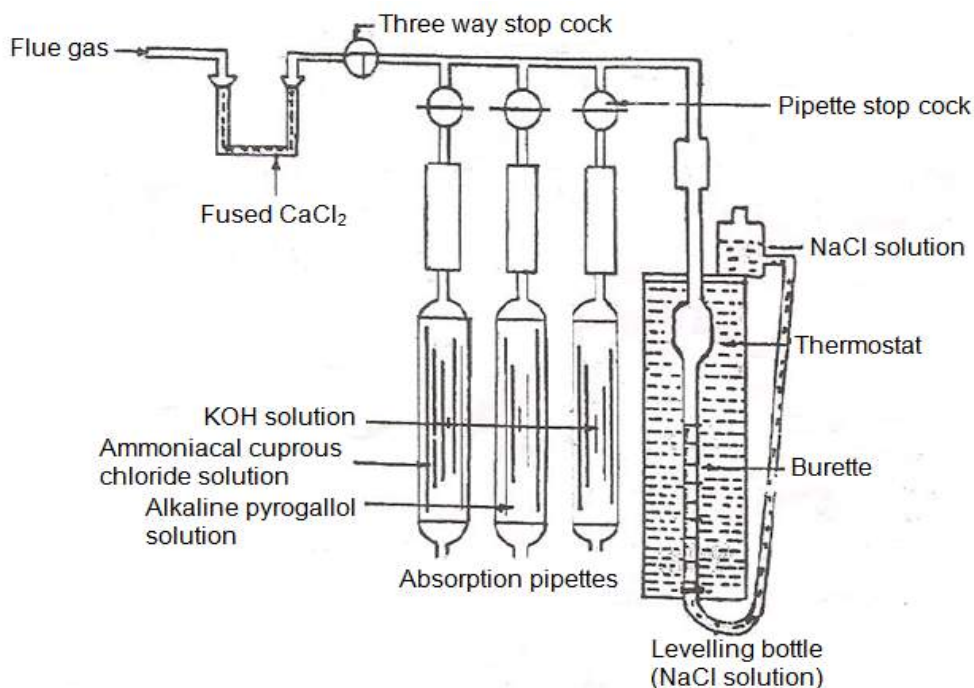

Then adjust the levelling bottle and exactly permit 100 ml of the flue gas as noted in the burette and close the three way stop clock completely. First, the stopper of the first absorption pipette having KOH solution is opened and the flue gas in the burette is forced into pipette solution by raising the levelling bottle. By repeatedly raising and lowering the levelling bottle, the gas is brought into intimate contact with the pipette KOH solution which absorbs the CO<sub>2</sub> gas completely. Then, the residual gases are taken into the burette and the levels of the KOH solution is made to stand in fixed mark. By adjusting the levelling bottle, the volume of residual gases after the removal of CO<sub>2</sub> by the absorption pipette is measured in the burette. The decrease in volume gives the volume of CO<sub>2</sub> in 100 ml. of the sample flue gas.

The same procedure is then repeated with the alkaline pyrogallol solution. After the absorption of O<sub>2</sub> in the absorption pipette, the pipette level is fixed and entry closed. After that the burette reading is noted by levelling with the levelling bottle. The further decrease in volume gives the volume of O<sub>2</sub> in 100 ml. of the flue gas.

Finally, the third absorption pipette is opened and by adjusting the levelling bottle up and down, the remaining flue gas is forced to pass through the ammoniacal cuprous chloride solution of the absorption pipette. This is done to have complete absorption of the remaining CO gas in the absorption pipette.

After this, the level of pipette is made fixed and entry closed. The residual gas finally present in the burette is then measured by using the levelling bottle. The decrease in value from the last noted value gives the volume of CO present in 100 ml. of the flue gas.

The percentage of nitrogen is obtained by the difference.

### Summary

In this lesson, combustion, combustion calculations and flue gas analysis are discussed.

## QUESTIONS

### PART – A

1. Define combustion.
2. Write the complete equation for the combustion of methane present in a fuel.
3. What is flue gas?

### PART – B

1. Mention the use of flue gas analysis.
2. Name the reagents used for the absorption of CO<sub>2</sub>, O<sub>2</sub> and CO in flue gas analysis.

### PART – C

1. Explain flue gas analysis by Orsat apparatus.
2. Calculate the mass of oxygen required for the combustion of 1 kg of a carbon, hydrogen and sulphur.
3. A sample of hydrocarbon contains 18.18% hydrogen and 81.82% of carbon by weight. Find the mass of air required for the complete combustion of 1 kg of the fuel.
4. A sample of coal was found to have the following composition.  
C = 75%, H<sub>2</sub> = 5.2%, O<sub>2</sub> = 12.1%, N<sub>2</sub> = 3.2% and ash = 4.5% by mass.
  - i. Calculate the amount of air required for complete combustion of 1 kg of coal.
  - ii. Calculate the amount of air required for complete combustion of 1 kg of coal if 40% excess air is used.
5. A fuel is found to contain C = 90%, H = 6%, S = 2.5%, O<sub>2</sub> = 1% and ash = 0.2% by mass.
  - i. Calculate the amount of air required for complete combustion of 1 kg of fuel.

- ii. Calculate the amount of air required for complete combustion of 1 kg of fuel if 25% excess air is used.
6. A gaseous fuel has the following composition by volume.  $H_2 = 15\%$ ,  $CO = 30\%$ ,  $CH_4 = 3\%$ ,  $CO_2 = 5\%$ ,  $O_2 = 2\%$  and remaining  $N_2$ . Calculate the volume of air needed for complete combustion of  $1\text{ m}^3$  of fuel.
7. The composition of gaseous fuel is Carbon monoxide = 22%, Hydrogen = 14%, Methane = 4%, Carbon dioxide = 6%, Nitrogen = 52% and Oxygen = 2% by volume. Calculate the volume of air required for the combustion of  $1\text{ m}^3$  of the fuel.
8. A gaseous fuel has following composition by volume. Methane = 5%, Hydrogen = 20%,  $CO = 25\%$ ,  $CO_2 = 6\%$  and the rest nitrogen. If 20% excess air is used for combustion, calculate the volume of air supplied per  $\text{m}^3$  of fuel.
9. A fuel contains 45%  $H_2$ , 40%  $CO$ , 12%  $CH_4$  and 3%  $O_2$  by volume. Excess air supplied is 50%. Determine the volume of air required to burn  $1\text{ m}^3$  of the fuel.

#### **TEST YOUR UNDERSTANDING**

1. How to distinguish between complete and incomplete combustion of coal.
2. How can you analyse the masses of  $CO_2$  and  $H_2O$  produced during combustion of a fuel?
3. Why a good fuel must have low ash content?

## 2.3.REFRACTORIES

### INTRODUCTION

Refractories find wide application in linings of the furnaces, tanks, converters, kilns, crucibles, ladles, etc. employed for the manufacture of metals, cement, glass, steel, ceramics, paper, etc.

#### Refractories

**Refractories are materials which can withstand very high temperature.** They are resistant to heat and corrosive action of gases, metallic liquids and slags. Examples: Fire clay, Silica.

#### Requirements of a good refractory

##### 1. Refractoriness

It is the ability to withstand very high temperature without deformation during operation.

##### 2. Strength or refractoriness under load (RUL)

They must possess high mechanical strength even at very high temperature and bear maximum possible load without breakage.

##### 3. Thermal expansion

A good refractory should have low thermal expansion under normal conditions.

##### 4. Thermal conductivity

In general, a good refractory must have low thermal conductivity to reduce heat losses by radiation. But, when heat is to be supplied from outside, the refractory must possess good conductivity.

##### 5. Porosity

A good refractory should not be porous. In porous refractory, the molten metal and slag enters and weaken the structure. But, porosity helps in the thermal shock-resistance of refractories.

##### 6. Thermal spalling

A good refractory must have low thermal spalling. It is breaking, cracking, peeling off or fracturing of the refractory under high temperature.

##### 7. Chemical composition

A good refractory must be chemically inert.

## Classification

The refractories are classified into three types based on the chemical properties.

1. Acid refractories
2. Basic refractories
3. Neutral refractories

Sl. No.	Type of refractory	Examples	Uses
1	Acid refractories	1. Zirconia 2. Silica	Used in furnaces where the charge and slag are acidic in nature
2	Basic refractories	1. Magnesite 2. Dolomite	Used in furnaces where the charge and slag are basic in nature
3	Neutral refractories	1. Chromite 2. Alumina	Used in furnaces where the charge and slag are either acidic or basic in nature

## Uses of a few refractory bricks

### a. Silica bricks

It contains 90-95% silica and about 2% lime.

1. They are used in open hearth furnaces, electric furnaces and glass furnaces.
2. They are used in coke-ovens and gas retort settings.
3. They are also used in lining of acid converters.

### b. Fire clay bricks

It contains major portion of alumina and silica and small percentage of  $K_2O$ ,  $FeO$ ,  $CuO$  and  $MgO$ .

1. They are used in blast furnaces and open hearth furnaces.
2. They are used in stoves, crucibles, furnaces, kilns, regenerators and charging doors.

### c. Alumina bricks

It contains more percentage of  $Al_2O_3$ .

1. They are used in vertical shaft kilns for burning lime.
2. They are used in linings of rotary kiln in cement manufacture.



3. They are used in brass melting reverberatories, lead-dressing reverberatory furnaces, and aluminium melting furnaces and in oil fired furnaces.

### **Summary**

In this lesson, different types of refractories, properties and their uses are discussed.

## **QUESTIONS**

### **PART – A**

1. What are refractories?
2. What are the types of refractories?
3. Give two examples for acidic refractories.
4. Give two examples for basic refractories.
5. Give two examples for neutral refractories.

### **PART – B**

1. Mention any three requirements of a good refractory.
2. List the specific uses of fire clay bricks.
3. List the specific uses of silica bricks.
4. List the specific uses of alumina bricks.

### **PART – C**

1. What are the requirements of a good refractory?
2. How are refractories classified? Explain with examples and uses.
3. Mention the uses of fire clay bricks, silica bricks and alumina bricks.

### **TEST YOUR UNDERSTANDING**

Surf the net for various types of furnaces.

## UNIT III

### EXTRACTION OF METALS, POWDER METALLURGY, ALLOYS AND ABRASIVES

#### 3.1 EXTRACTION OF METALS

##### INTRODUCTION

Most of the elements are metals. Metals occur in nature sometimes freely but mostly in the combined state as oxides, sulphides, carbonates etc.,

**Metallurgy is the branch of science and technology concerned with the properties of metals and their production and purification of metal from its ore.**

Metallurgy deals with extraction of a metal in its pure form from its ore. The various stages involved in extracting a metal from its ore are

1. Crushing and grinding of ore
2. Concentration of the ore by physical methods
3. Conversion of concentrated ore into its oxide by chemical reactions
4. Conversion of metal oxide into metal by reduction and
5. Purification of metal by a suitable method

This lesson deals with the metallurgy of two important metals namely tungsten (W) and titanium (Ti) which are mainly used to prepare hard steel varieties.

##### Metallurgy of tungsten

##### Ores

The main ores of tungsten are

1. Wolframite ((Fe, Mn)WO<sub>4</sub>)
2. Scheelite (CaWO<sub>4</sub>)
3. Tungstenite (WS<sub>2</sub>)
4. Solzite (PbWO<sub>4</sub>)
5. Cuproscheelite (CuWO<sub>4</sub>)

##### Extraction of tungsten from Wolframite ore

1. The finely powdered ore of tungsten is concentrated by electromagnetic separation.
2. The concentrated ore is fused with sodium carbonate in an oxidizing atmosphere of air. Tungsten forms sodium tungstate.

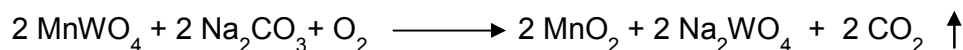
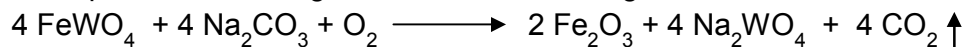

3. The fused mass is extracted with water. The solution of sodium tungstate is concentrated to get the crystals. The crystals are filtered out. Sodium tungstate crystals are again dissolved in minimum quantity of water and acidified with hydrochloric acid. Hydrated tungstic acid is precipitated.



4. Tungstic acid thus obtained is ignited strongly to remove water. The formed  $\text{WO}_3$  is reduced with hydrogen to get tungsten.

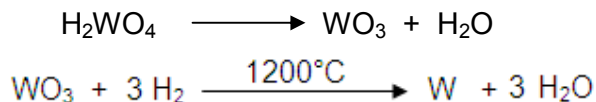

5. Tungsten thus obtained is purified by converting it into vapours of tungsten hexachloride and the vapours when passed over a heated tungsten wire give pure tungsten.

### Properties

Tungsten is a hard silvery white metal. It is as heavy as gold. It has highest melting point ( $3414^\circ\text{C}$ ). Its wire is very hard and has high tensile strength. It is resistant to acids.

### Uses

1. It is used for making filaments of electric bulbs.
2. It is used for making strings for musical instruments.
3. It is mainly used for preparing special type of steels.
4. It is used as anti-cathode in X-ray tubes.
5. It is used for making surgical instruments.
6. Tungsten carbide is used to prepare very hard alloys.
7. Sodium tungstate is used for making fire-proof fabrics. It is also used as a mordant in dyeing.
8.  $\text{WO}_3$  is used as yellow pigment.

### Metallurgy of titanium

#### Ores

The main ores of titanium are

1. Rutile ( $\text{TiO}_2$ )
2. Ilmenite ( $\text{FeTiO}_3$ )

## Extraction of titanium from rutile ore

The finely powdered ore is concentrated by gravity separation method.

### Stage I: Purification of $\text{TiO}_2$

The concentrated ore is treated with hot concentrated sulphuric acid and then digested with excess of water. Titanium hydroxide is precipitated.

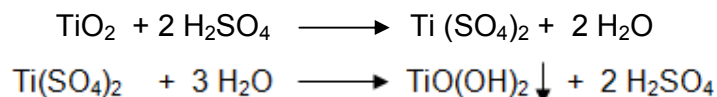

The precipitated titanium hydroxide on heating gives pure titanium dioxide.

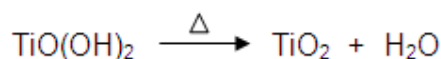

### Stage II

The pure titanium dioxide is converted into titanium tetrachloride ( $\text{TiCl}_4$ ) vapours by heating it with carbon in a current of chlorine at  $900^\circ\text{C}$ .

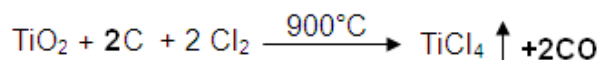

### Stage III

The vapours of  $\text{TiCl}_4$  are collected and condensed to get  $\text{TiCl}_4$  liquid.  $\text{TiCl}_4$  liquid, which boils at  $136^\circ\text{C}$ , is purified by distillation.

### Stage IV

$\text{TiCl}_4$  is then reduced with sodium metal in an argon atmosphere to get titanium.

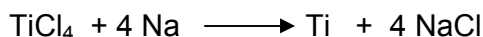

The metal thus obtained is washed with 3% nitric acid to remove the impurities.

### Stage V

## Van Arkel Method

Finally, the metal is purified by Van Arkel method. In this method, impure titanium is heated with iodine vapours to get titanium tetra iodide vapours. These vapours are taken to a different chamber and passed over a heated tungsten wire at  $1400^\circ\text{C}$ .  $\text{TiI}_4$  decomposes to give pure titanium.

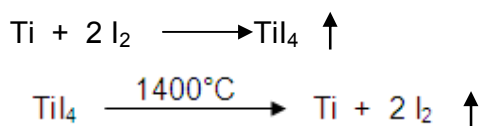

## Properties

Titanium is a shining white metal. It has low density and high melting point. It is a good conductor of heat and electricity. It has better corrosion resistance.

## Uses

1. It is used in aircrafts industry.
2. It is used in gas turbine engines.
3. It is used in marine equipments.
4. It is also used for hardening steel.
5.  $\text{TiO}_2$  is used as a semi-precious artificial gem.

## Summary

In this lesson, extraction of tungsten and titanium, their properties and uses are discussed.

## QUESTIONS

### PART – A

1. Name two ores of tungsten.
2. Name two ores of titanium.

### PART – B

1. List the uses of tungsten.
2. List the uses of titanium.

### PART – C

1. Explain the extraction of tungsten from its ore. Mention its uses.
2. Explain the extraction of titanium from its ore. Mention its uses.

## TEST YOUR UNDERSTANDING

1. What are the alloys prepared using titanium?
2. What are the alloys prepared using tungsten?

## **3.2 POWDER METALLURGY**

### **INTRODUCTION**

Generally, metal components are prepared by pouring molten metal in the mould castings. Powder metallurgy is a new technique in which moulds are made using compressed metal powders, even though this method is more expensive (As it involves preparation of metal powder). This method has many advantages over the traditional method. Metals and alloy can be made into metal powders. The metal powder is then used for making the articles.

#### **Powder metallurgy**

**Powder metallurgy is an art of making metal articles of desired shape using metal powder by heat treatment and compression.** By this method, even complicated structures can be moulded easily.

Eg. Aluminium and bronze powders are used in paints. Iron powder is used in welding rods.

Articles can be made by using

1. Single metal powder
2. Mixture of metal powders
3. Mixture of metal and non-metal powders

The powder metallurgical process consist of the the following two steps.

1. Powder production
2. Powder fabrication

#### **Powder production**

Metal powders with particle size ranging from 1 to 100 microns are produced. Usually metal powders with particle size 10 to 20 microns are predominant. The metal powders produced should be pure. They should also have the correct particle size and shape.

Metal powders are produced by any one of the following methods.

#### **Preparation of metal powder**

##### **1. Atomization**

**Atomisation method is suitable for metals with low melting point like zinc, lead, tin, aluminium etc.**

In this method, a metal is heated to convert it into a molten metal. The molten metal is then forced through an orifice. A compressed stream of air is passed over the molten metal. The liquid metal is broken and sprayed into minute droplets. The droplets are cooled and condensed to get metal powder.

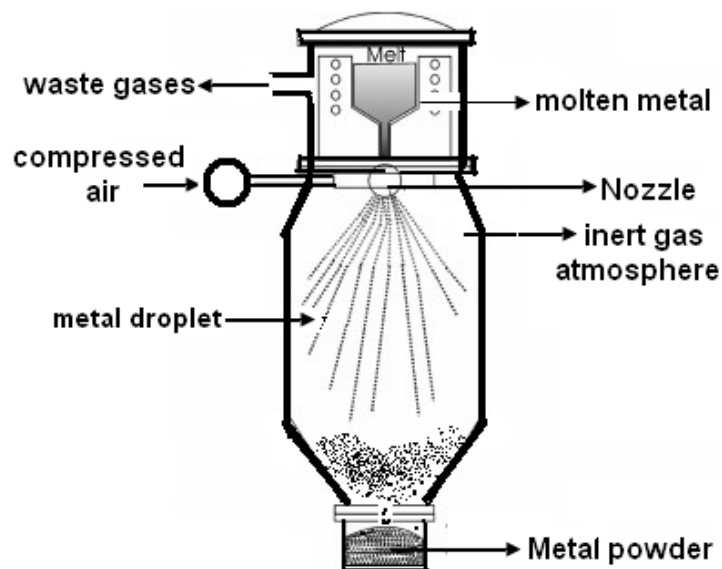

To avoid oxidation of metal powder, inert gas is used instead of air. Powders of low melting metals like zinc, lead and tin are produced by this method.

Advantages:

1. Pure metal powder is obtained.
2. The production cost is high.
3. The grain size of the powder can be controlled.

## 2. Reduction of metal oxide

**Reduction method is suitable for the metals with high melting point like tungsten, iron, copper, nickel etc.**

Metal powder can be obtained by passing reducing agent like carbon monoxide or hydrogen on heated metal oxides. The metal thus obtained is then crushed and ground to particle of desired size.

Example:

1. Powder copper can be obtained by reducing copper oxide using hydrogen.

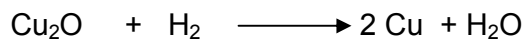

2. Tungsten powder is obtained by passing hydrogen over  $\text{WO}_2$ .

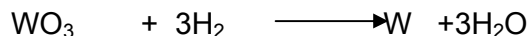

**Advantages:**

1. The yield is higher in this method.
2. This method is highly convenient and economical.

### **Applications of powder metallurgy**

1. Used for making compact, complicated geometrical shaped objects.
2. Used for making metal bearings embedded with graphite powder.
3. Generator brush and electrical contact brush composite containing highly conductive copper and graphite with lubricating property is manufactured by powder metallurgy.
4. Used for making dense ductile sheets of metals like tungsten and molybdenum.
5. Used for making filaments for bulbs (Tungsten filament).
6. Used to prepare magnetic materials.
7. Very hard cutting tools from carbides of tungsten, titanium, tantalum etc, are manufactured.
8. Used for making diamond impregnated cutting tools.
9. Used for making wear resistance cutting tools (Eg: with cobalt and nickel metal powder).
10. Powder metallurgy techniques are used in surgical implants and in medicinal field.

### **Summary**

In this lesson, importance of powder metallurgy and methods of production of metal powders and applications of powder metallurgy are discussed.

### **QUESTIONS**

#### **PART – A**

1. Define powder metallurgy.
2. Mention the methods of preparation of metal powders.

#### **PART – B**

1. Explain the preparation of metal powder by atomization.
2. Explain the preparation of metal powder by reduction of metal oxide.

#### **PART – C**

1. Explain the two methods of preparation of metal powders.
2. Mention the applications of powder metallurgy.

### **TEST YOUR UNDERSTANDING**

What are the electrical components prepared by powder metallurgy?



### 3.3 ALLOYS

#### INTRODUCTION:

A metal that is normally very soft and malleable, such as aluminium, can be altered by alloying it with another soft metal, like copper. Although both metals are very soft and ductile, the resulting aluminium alloy will be much harder and stronger. Gold when combined with copper becomes suitable to make jewels.

The melting point of Lead is  $327^{\circ}\text{C}$ . The melting point of tin is  $231^{\circ}\text{C}$ . Solder is an alloy of tin and lead. The melting point of solder is  $183^{\circ}\text{C}$ . The low melting point of this alloy is made use of in electrical connections.

The mechanical properties will often be quite different from those of its individual constituents. Hence alloys play an important role in engineering materials.

#### Alloy

**Alloys are homogeneous mixture of two or more metals.**

Eg. Brass, Bronze, Stainless steel.

Generally, alloys are prepared by fusing together the different ingredients (metals) in a furnace. The alloys exhibit different properties when compared with the properties of metals in them.

#### Purpose of alloying

1. To increase the hardness of the metal.
2. To increase the tensile strength of the metal.
3. To make it corrosion resistant.
4. To enhance the malleability and ductility.
5. To get attractive surface and appearance.
6. To make it abrasion resistant.
7. The machinability of the metal can be improved.
8. Melting point of the metal can be decreased.
9. The colour and metallic luster can be improved.

#### Types of alloys

Alloys are classified into two types.

1. Ferrous alloys
2. Non-ferrous alloys

## Ferrous alloys

**Alloys which contain containing iron as the main (major) constituent are called as ferrous alloys.**

Examples: Stainless steel, chromium steel and vanadium steel.

Sl. No.	Name of the alloy	Composition	Uses
1	Stainless steel	Chromium = 14% Nickel = 1% Carbon = 1% Iron = 84%	1. Used for making kitchen utensils. 2. Used for making surgical instruments 3. Used for making automobile parts
2	Chromium steel	Chromium = 0.5-18% Carbon = 0.15 - 1.3% Iron = 80.7 - 99.35%	1. Used for making rock cutting machines 2. Used for making files 3. Used for making ball bearings 4. Used for making connecting rods
3	Vanadium steel	Vanadium = 0.5% Chromium = 1.1 - 1.5% Carbon = 0.4 - 0.5% Iron = 97.5 - 98%	1. Used for making gears and bearings 2. Used for making axles 3. Used for making springs and pistons

## Non-ferrous alloys

**Alloys which do not contain containing iron as the main constituent are called as non-ferrous alloys.**

Examples: Nichrome, Dutch metal, German silver, gun metal and duralumin

Sl. No.	Name of the alloy	Composition	Uses
1	Nichrome	Nickel = 60% Chromium = 12% Manganese = 02% Iron = 26%	1. Used in making resistance coils 2. Used for making heating elements in stoves, electric irons, water heater and toasters

2	Dutch metal	Copper = 80% Zinc = 20%	1.Used for making cheap jewellery 2.Used for making musical instruments 3.Used for making battery caps 4.Used for making flexible hoses
3	German silver	Copper = 50% Nickel = 30% Zinc = 20%	1.Used for making coins 2.Used for making ornaments 3.Used for making decorative materials
4	Gun metal	Copper = 88% Tin = 10% Zinc = 02%	1.Used for making bearings 2.Used for making coins 3.Used for making hydraulic Fittings 4.Used in foundry works
5	Duralumin	Aluminium = 95% Copper = 04% Magnesium = 0.5% Manganese = 0.5%	1.Used in building aircrafts 2.Used for making automobile parts and locomotive parts 3.Used for making surgical instruments 4.Used for making cables

### Summary

In this lesson, the importance of alloying, composition and uses of ferrous alloys and non-ferrous alloys are discussed.

### QUESTIONS

#### PART – A

1. What are alloys?
2. What are the two types of alloys?
3. Give the composition of Stainless steel.
4. Give the composition of Chromium steel.
5. Give the composition of Vanadium steel.
6. Give the composition of Nichrome.
7. Give the composition of Dutch metal.
8. Give the composition of German silver.
9. Give the composition of Gun metal.
10. Give the composition of Duralumin.

#### PART – B

1. What are ferrous alloys? Give examples.
2. What are non-ferrous alloys? Give examples.
3. Give the composition and uses of Stainless steel.
4. Give the composition and uses of Chromium steel.
5. Give the composition and uses of Vanadium steel.

6. Give the composition and uses of Nichrome.
7. Give the composition and uses of Dutch metal.
8. Give the composition and uses of German silver.
9. Give the composition and uses of Gun metal.
10. Give the composition and uses of Duralumin.

### **PART – C**

1. What are alloys? How are they classified? Give examples.
2. Explain the purposes of alloying.
3. Write a note on the following ferrous alloys.
  - a. Stainless steel
  - b. Chromium steel
  - c. Vanadium steel
4. Write a note on the following non-ferrous alloys.
  - a. Nichrome
  - b. Dutch metal
  - c. German silver
  - d. Gun metal
  - e. Duralumin

### **TEST YOUR UNDERSTANDING**

What are the alloys used in aircraft parts and automobile parts?

## 3.4 ABRASIVES

### INTRODUCTION

We have observed different hard and soft substances used for the cutting, grinding and polishing surfaces in day-to-day life.

- Hard silicon carbide discs are used in workshops in shaping machines.
- Emery sheets are used to clean the metal surfaces before painting them.
- Discs are used for sharpening knives and other cutting tools.
- Fine metal powders are used for mosaic polishing.

### Abrasives

**Abrasives are a hard substance which is used for cutting, grinding and polishing the surface of other materials.**

#### Hardness of an abrasive

Hardness is the main property of an abrasive. It is defined as the capacity of an abrasive to grind another substance. Harder the abrasive, better will be its capacity to grind the surface of other substances.

#### Moh's scale

Hardness of abrasives is measured in a scale called Moh's scale. In Moh's scale, the hardness of Diamond, which is the hardest among all the substances, is taken as 10. The hardness of Talc, which is the softest substance, is taken as 1. Thus, the hardness of other substances in Moh's scale lies in between 1 and 10.

#### Hardness of abrasive materials

Material	Hardness (Moh's scale)
Talc	1
Gypsum	2
Calcite	3
Fluorite	4
Appatite	5
Feldspar	6
Quartz	7
Topaz	8
Corundum	9
Diamond (C)	10

Generally, hardness of abrasives is measured by piercing a needle through it using some pressure. Hardness is measured in terms of the distance pierced by the needle in the abrasive material and comparing the same with a standard substance of known hardness.

The other important property of an abrasive is toughness. Abrasive material should be brittle so that it can function effectively. The other important character of an abrasive is its ability to withstand high temperature (Refractoriness).

### Classification

Abrasives are classified as natural and artificial abrasives. They are further classified as follows.

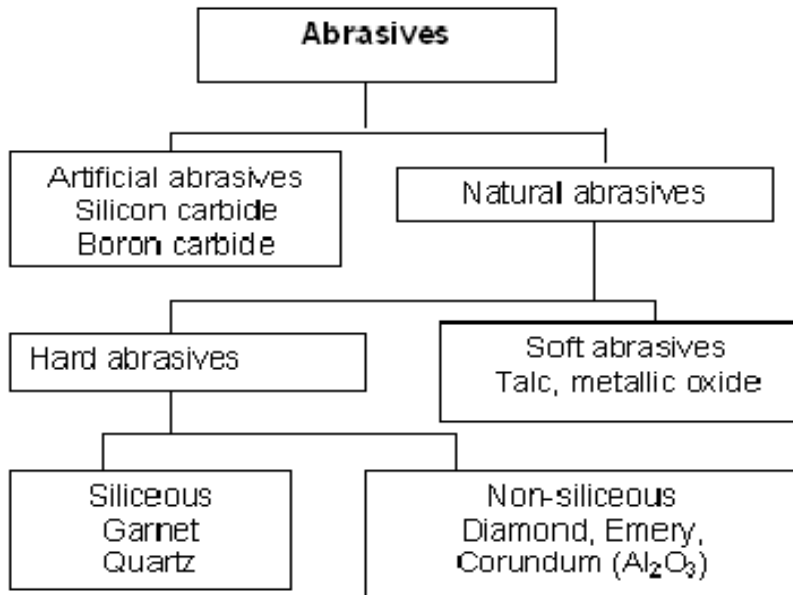

### Important natural abrasives

#### 1. Diamond

- It is a natural, hard, non-siliceous abrasive.
- It is the hardest substance in the world.
- It is an **allotrope** of carbon.
- It is the purest form of carbon.
- Its hardness in Moh's scale is 10.
- The impure varieties called Bort and carbanado are used as abrasives.

#### Uses

- It is used for cutting, grinding and polishing purposes.
- It is mainly used in rock drilling.

## 2. Corundum

- It is a natural, hard, non-siliceous abrasive.
- It is fused aluminium oxide ( $\text{Al}_2\text{O}_3$ ).
- It is obtained by fusing the ore of aluminium called Bauxite.
- Its hardness in Moh's scale is 9.

### Uses

- It is mainly used in grinding wheels.
- It is specially used for grinding paper pulp.

## 3. Emery

- It is a natural, hard, non-siliceous abrasive.
- It is a mixture of corundum ( $\text{Al}_2\text{O}_3$ ) and magnetite ( $\text{Fe}_3\text{O}_4$ ).
- The presence of magnetite decreases the hardness of corundum.
- Its hardness in Moh's scale is 7 to 9.

### Uses

- It is mainly used for scratching and rubbing surfaces.
- It is used for making abrasive paper and cloth.

### Types of emery

Depending on the percentage of alumina, emery is classified into the following three types.

Sl. No.	Type of emery	% of alumina	uses
1	Grecian emery	85%	In grinding wheels
2	Turkish emery	75%	Grinding and polishing the glass
3	American emery	60%	Used in metal and wood polishing work

## 4. Garnet

- It is a natural, hard, siliceous abrasive.
- It consists of trisilicates of alumina, magnesia and ferrous oxide.
- Its hardness in Moh's scale is 6.5.

### Uses

- It is used for grinding glass.
- It is used for making abrasive paper and cloth.

## Important synthetic abrasives

### 1. Silicon carbide (SiC)-carborundum:

It is also known as carborundum. It is a siliceous artificial abrasives. In hardness, it is almost equivalent to diamond 9.3.

#### Preparation

Silicon carbide is prepared by fusing a mixture of silica (sand) and carbon (coke) with some salt and saw dust in an electric arc furnace at 3000°C.

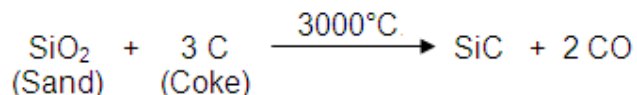

Salt and saw dust is added to infuse air into the product so that it can be broken into pieces easily.

The product obtained is first washed with strong acid followed by strong base to remove basic and acidic impurities respectively. Finally, it is washed with water.

#### Properties

- It is very hard and chemically inert.
- Its hardness in Moh's scale is 9.8.
- It can withstand very high temperature.

#### Uses

- It is used for making grinding wheels, cast iron and bronze.
- It is used for cutting and grinding glass.
- It is used for grinding granite.
- It is used for grinding carbides.

### 2. Boron carbide (B<sub>4</sub>C)

It is also known as norbide. It is also an artificial siliceous abrasives. It is harder than silicon carbide. It's hardness varies from 9.5 to 9.7 on Moh's scale.

#### Preparation

Boron carbide is prepared by heating a mixture of boron oxide (B<sub>2</sub>O<sub>3</sub>) and carbon (coke) in an electric arc furnace at 2500°C.

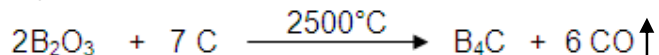

The product obtained is first washed with strong acid followed by strong base to remove basic and acidic impurities respectively. Finally, it is washed with water.

#### Properties

- It is chemically inert.



- It is harder than silicon carbide.
- Its hardness in Moh's scale is 9.5 to 9.7.

### Uses

- It is used for cutting steel.
- It is used for cutting tungsten carbide.
- It is used for grinding other hard materials.

### Summary

In this lesson, hardness of abrasives, their classification and applications are discussed.

#### QUESTIONS PART – A

1. What are abrasives?
2. What is Moh's scale?
3. Give two examples for natural abrasives.
4. Give two examples for synthetic abrasives.
5. What is carborundum?
6. What is norbide?

#### PART – B

1. How are abrasives classified? Give examples.
2. List the uses of diamond.
3. List the uses of corundum.
4. List the uses of emery.
5. List the uses of garnet.
6. List the uses of silicon carbide.
7. List the uses of boron carbide.
8. How is carborundum prepared?
9. How is norbide prepared?

#### PART – C

1. What are abrasives? How are they classified? Give examples.
2. Write a note on the following natural abrasives.
  - a. Diamond
  - b. Corundum
  - c. Emery
  - d. Garnet
3. How is silicon carbide prepared? Explain. Give its properties and uses.
4. How is boron carbide prepared? Explain. Give its properties and uses.

#### TEST YOUR UNDERSTANDING

1. What is grit or grain size of an abrasive material? How does it help to select abrasives for specific jobs?
2. What is mesh number? Explain.

## UNIT IV

### CEMENT, CERAMICS, LUBRICANTS AND ADHESIVES

#### 4.1 CEMENT

##### INTRODUCTION

Cement is a building material. It is applied in the form of a soft paste with sand and water and later it sets into a hard mass. It is a mixture of calcareous material and argillaceous material. It is a mixture of silicates of calcium and aluminium.

##### Portland cement

A paste of cement with water on setting and hardening gave a hard mass whose colour and hardness were similar to those of stones from Portland in England. Thus, it derived the name Portland cement. Portland cement is a mixture of silicates of calcium and aluminium.

Major constituents of cement

1. Dicalcium silicates( $2\text{CaO}.\text{SiO}_2$ )-28%[ $\text{C}_2\text{S}$ ]
2. Tricalcium silicates( $3\text{CaO}.\text{SiO}_2$ )-46%[ $\text{C}_3\text{S}$ ]
3. Tricalcium aluminates( $3\text{CaO}.\text{Al}_2\text{O}_3$ )-10%[ $\text{C}_3\text{A}$ ]
4. Tetra calcium aluminoferrite( $4\text{CaO}.\text{Al}_2\text{O}_3.\text{Fe}_2\text{O}_3$ )-9%[ $\text{C}_4\text{AF}$ ]
5. Small quantities of CaO and MgO-7%

##### Manufacture of cement by wet process

##### Raw materials required

1. Calcareous materials – These materials supply lime  
Examples: Limestone, chalk, marble
2. Argillaceous materials – These materials supply silica  
Example: Clay
3. Powdered coal (fuel)
4. Gypsum

##### Process

The cement is manufactured by wet process as follows.

1. The limestone is crushed and powdered well.
2. The clay is intimately mixed with water in wash mill.
3. The powdered limestone and wet clay are mixed and made into a paste in a grinding mill. This paste is known as slurry. The slurry contains 30 to 40% water.
4. The slurry is fed into the top of the rotary kiln. The rotary kiln is made of steel plates lined with fire bricks.

5. The kiln is heated by burning powdered coal which is injected at the lower end by an air blast.
6. In the upper part of the kiln (drying zone) where the temperature is  $400^{\circ}\text{C}$ , the slurry loses all its water.
7. When the charge enters the middle portion of the kiln (calcinations zone) where the temperature is about  $900 - 1000^{\circ}\text{C}$ , limestone decomposes to form  $\text{CaO}$  and  $\text{CO}_2$ .
8. Then the charge enters lower portion of the kiln (burning zone) where the temperature is about  $1400^{\circ}\text{C}$ . Lime and clay combines to form calcium silicates and aluminates called clinker.
9. The hot clinker is cooled and then grinded with 3 – 4% gypsum in a grinding mill. Gypsum retards the setting of cement. In the absence of gypsum, cement sets rapidly.
10. The cement coming out of the grinding mills is stored in concrete storage tanks and then packed in bags.

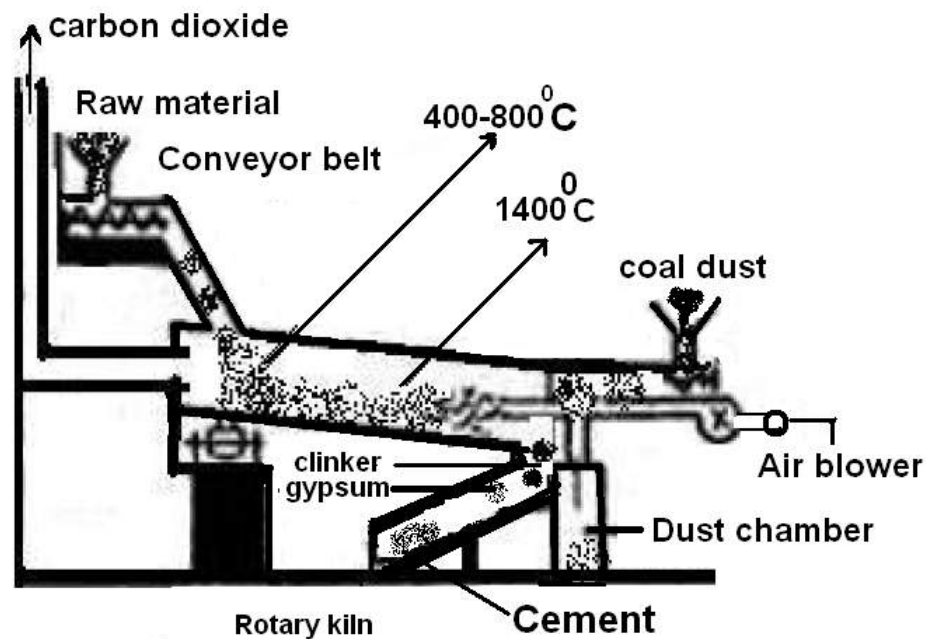

### Setting of cement

When water is added to cement, sudden setting of cement occurs (flash set). The hardening of cement by the addition of water is known as setting of cement.

The setting and hardening of cement are mainly due to hydration and hydrolysis reactions of the different constituents present in cement.

The dicalcium silicate ( $C_2S$ ), tricalcium silicate ( $C_3S$ ), tricalcium aluminate ( $C_3A$ ) and tetracalcium aluminoferrite ( $C_4AF$ ) present in cement undergoes hydration. **(Equation not for Examination)**

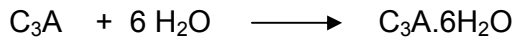
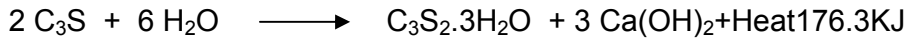
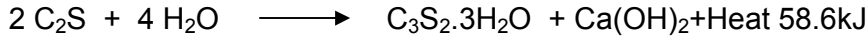

During this process, anhydrous soluble compounds are converted into hydrated insoluble compounds. The hydrated insoluble gel hardens due to dehydration. Finally, after dehydration, the insoluble gel sets into hard mass. It surrounds the sand and binds it strongly with interlocking crystals of  $Ca(OH)_2$ . This process is known as setting of cement.

### Summary

In this lesson, manufacture of Portland cement and setting of cement are discussed.

### QUESTIONS

#### PART – A

1. What is cement?
2. What is Portland cement?
3. Why is gypsum added during the manufacture of cement?

#### PART – B

1. What are the raw materials required for the manufacture of Portland cement?
2. Write a note on setting of cement.

#### PART – C

1. Explain the manufacture of Portland cement by wet process.

### TEST YOUR UNDERSTANDING

1. What are the various types of cement?
2. How the quality of cement is tested?

## 4.2 CERAMICS

### INTRODUCTION

Ceramics find wide application in engineering, medical and domestic usage. Ceramics are increasingly used in motor parts (e.g. ceramic disc brakes, ceramic balls, etc.). Ceramic engine does not require cooling system. They withstand heat upto 3300°C. One of the main applications of ceramics is white pottery.

### Ceramics

**Ceramics are inorganic non-metallic materials that are processed at high temperature and subsequent cooling.**

Examples: Ceramic wash basin, ceramic tiles, etc.

### White pottery

They are ceramic materials of china clay which is in white colour after firing is called white wares. They consist of a refractory body and glossy coating.

The raw materials used for manufacture of white pottery are given below.

1. China clay(kaolin)[ $\text{Al}(\text{OH})_4 \text{SiO}_5$ ]
2. Feldspar [ $\text{KAlSiO}_2$ ]
3. Flint ( $\text{SiO}_2$ )/quartz.

### Manufacture of white pottery

#### Step-I

#### Preparation of body ware

The raw materials are made into fine powder and mixed with water to form a paste.

The excess of water is removed by filtration. The article is prepared from the paste either by hand moulding or by using potter's wheel.

It is dried and then fired in a 'biscuit' oven to get porous ware called 'Bisque'.

#### Step-II

#### Glaze

In order to make the porous ware (Bisque) into water-tight article, it is covered with glaze by melting it over the surface of the body.

Slurry of glaze is prepared by mixing Feldspar, silica and boric oxide with water. Now the fired articles are dipped in the slurry of glaze and again fired. Now a smooth, glossy and non-porous surface is formed on the articles.

#### Step-III

#### Decoration

To decorate the article, design are made on the article using pigments and fired again.

Eg.

Iron oxide pigments red colour.

Cobalt oxides give blue colour.

### **Uses of White ware**

They are used for the preparation of

1. Spark plugs
2. Electrical insulators
3. Laboratory equipments
4. Crucibles, dishes, insulators sanitary wares etc.

### **Glazing**

**Glazing is the process of giving a smooth, glossy, non-porous surface on the articles using glazes.**

A glaze is a fine powder consisting of glass forming materials like lead silicates, borosilicates etc. They are colourless glazing and colour glazing mixtures. Colourless glazing is done with glass forming materials like lead silicate and borosilicate. Colour glazing is done by mixing coloured metal pigments with glass forming materials.

Examples: Iron oxide for red and brown

Copper oxide for green

Cobalt oxide for blue

### **Purpose of glazing**

1. To get decorative effect.
2. To make the surface impervious (non-porous) to liquids and water..
3. To improve appearance of the article.
4. To increase the durability of ceramic material.
5. To get a smooth glossy appearance.
6. To protect the surface from atmospheric action.

### **Methods of glazing**

There are two methods of glazing

1. Salt glazing
2. Liquid glazing

#### **1. Salt glazing**

In salt glazing, common salt (sodium chloride) is used for getting glossy films over articles. The process consists of throwing sodium chloride into furnace, when the article is in red-hot condition. At high temperature, sodium

chloride vapours reacts with silica in the article to form a smooth glossy and impervious film of 'sodium silicate'. This is known as salt glazing.

## **2. Liquid Glazing.**

Slurry of glaze is prepared by mixing Feldspar, silica and boric oxide with water. Now the articles are dipped into the slurry of glaze and then fired. Now a smooth, glossy and non-porous surface is formed on the articles. This is known as Liquid Glazing.

## **Summary**

In this lesson, various steps involved in the manufacture and uses of ceramics are discussed. Glazing, purpose of glazing and salt glazing are also discussed.

## **QUESTIONS**

### **PART – A**

1. What are ceramics?
2. Define white pottery.
3. What is called bisque?
4. What is glazing?

### **PART – B**

1. What are the raw materials required for the manufacture white pottery?
2. List the uses of white pottery.
3. Explain salt glazing.

### **PART – C**

1. Describe the manufacture of white pottery.
2. What are the purposes of glazing?
3. Write a note on glazing.

## **TEST YOUR UNDERSTANDING**

What are the engineering applications of ceramics?

## 4.3 LUBRICANTS

### INTRODUCTION

Whenever a machine works, its moving, sliding or rolling parts rub against each other with the result of that a friction is developed. This friction causes a lot of wear and tear of the concerned surfaces. Further due to friction, large amount of energy is dissipated in the form of heat and thus causes loss in the efficiency of a machine. Moreover, the heat produced due to friction causes damage to the moving parts.

The above ill effects can be minimized by applying a thin layer of certain substances known as lubricant in between the moving parts.

The process of applying the lubricant in between the two moving or sliding surfaces is called as lubrication.

### Lubricant

**Lubricant may be defined as the substance which reduces the friction between the two moving surfaces or parts of a machine.**

### Characteristics of a lubricant

1. It should have enough viscosity and oiliness.
2. It should have flash and fire points higher than the operating temperature of the machine.
3. It should be chemically inert.
4. It should not come out of the surface under pressure.
5. It should not evaporate easily.
6. It should stick on the surface.
7. It should leave low carbon residue.
8. It should not form emulsion with water.
9. It should have cloud and pour points lower than the operating temperature of the machine.
10. The volatility of the lubricating oil should be low.
11. It should possess a higher resistance towards oxidation and corrosion.

### **Classification of lubricants**

Lubricants may be broadly classified as follows.

1. Solid lubricants
2. Semi-solid lubricants
3. Liquid lubricants



## **Solid lubricants**

The most widely used solid lubricants are graphite and molybdenum sulphide.

Solid lubricants are used in the following areas.

- (a) For heavy machinery working as a crude job at very high loads.
- (b) When the operating temperature or load is very high.
- (c) Where a liquid or semi-solid lubricant film cannot be maintained.

### **1. Graphite**

Graphite is an allotrope of carbon. Graphite has a layered structure of carbon atoms. The carbon atoms are joined together by strong covalent bonds. The adjacent layers are held together by the weak Vanderwall's force. Thus, they form a network of hexagons. Graphite is soapy to touch, non-inflammable and not oxidized in air below 375°C. It is used as a lubricant in the form of powder or as suspension in oil or water. It fills the cavities and prevents the friction. It is used for lubricating the joints or railways tracks.

Graphite can be used as a dry powder or as a colloidal dispersion.

A dispersion of graphite in water is called aqua dag and that in oil is called oil dag.

#### **Uses**

It is used as a lubricant in IC engines, air compressors, lathes, food-stuff industry, railway track joints, general machine job works, etc.

### **2. Molybdenum sulphide**

Fine powder of molybdenum sulphide is used as lubricant. It has the capacity to withstand very high temperature. It is stable in air upto 500°C.

#### **Uses**

It is used as lubricant in high-speed machines.

### **Semi-solid lubricant**

Example: Grease and Vaseline

#### **Grease**

**It is a mixture of mineral oil and soap.** It is used for heavy load and low speed machines. It is mainly used in bearing and gears. Grease is a semi-solid lubricant obtained by thickening of lubricating oil by the addition of a metallic soap. The thickener is usually sodium, calcium, and lithium or aluminium soap.

Greases are manufactured by saponification of fats with alkali followed by adding hot lubricant oil under severe agitation. Their properties depend on both the base used for saponification and the fatty acid present in the oil.

## **Liquid lubricants**

### **Vegetable oils**

They are commonly used liquid lubricants.

Examples: Castor oil, coconut oil, etc.

They are classified as drying and semi-drying oils. They are easily oxidized by atmosphere.

### **Animal oils**

They are oils of animal origin. They are mainly animal fats.

Examples: Tallow oil, whale oil, lards oil, coconut oil and olive oil etc.,

They are very costly. Hence, they find little use as lubricants. They are also easily oxidized by atmosphere.

### **Mineral oil**

Hydrocarbons with higher molecular mass obtained by the fractional distillation of petroleum are used as lubricants. They are obtained from the paraffin residue.

Examples: Paraffin oil, lubricating oil, etc.

### **Blended oils**

They are mixture of vegetable oils and petroleum products. They show improved properties. Different oils are suitably mixed depending on the requirement. They are synthetic lubricants.

### **Summary**

In this lesson, lubricant, purpose of lubrication, properties and types of lubricants are discussed.

## **QUESTIONS**

### **PART – A**

1. What is a lubricant?
2. How are lubricants classified?
3. Mention the uses of graphite.
4. Mention the uses of molybdenum sulphide.

### **PART – B**

1. How are lubricants classified? Give examples.
2. Write a note on semi-solid lubricant.

### **PART – C**

1. List the essential characteristics of lubricants.
2. Write a note on solid lubricants.
3. Write a note on liquid lubricants.

## **TEST YOUR UNDERSTANDING**

1. What types of lubricants are used for transformers?
2. Why does graphite act as a good lubricant on the surface of the motion?

## 4.4 ADHESIVES

### INTRODUCTION

**Any substance capable of holding materials together by surface attachment is known as adhesive.**

The bodies held together by an adhesive are known as 'adherends', while the process of holding one adherend to another by adhesive is called 'bonding'. The final assembly of two adherends and the adhesive is called 'bond'.

The quality of an adhesive is judged by the following factors.

1. Degree of tackiness (i.e., stickiness)
2. Rapidity of bonding
3. Strength of bond after setting or drying and
4. Durability

Examples: Starch, glue, gum, phenol-formaldehyde, cellulous nitrate, PVC, etc.

### Requirements of a good adhesive

1. It should have high tackiness.
2. It should form a strong bond.
3. It should have low viscosity.
4. The bonding should be rapid.
5. It should be highly durable.
6. It should have negligible creep under stress.
7. It should be water repellent.
8. It should be resistant to insects and fungi.

### Classification of adhesives

Adhesives are classified into two types.

- a. Natural adhesives
- b. Synthetic adhesives

#### Natural adhesives

##### a) Starch

Starch adhesives are obtained by heating a starch suspension in water at 150°C. The characteristics of starch adhesives are,

1. They are very cheap.
2. They spread quickly and dry quickly.
3. They do not give any foul smell.
4. They can be applied in cold as well as hot conditions.
5. They have low resistance to moisture and low adhesive strength.

## **Uses**

They are used in making envelopes, stamps, note books, binding books, etc.

### **b) Shellac**

Shellac is one the oldest adhesive. It has to be applied in hot condition. The bond developed has good strength, good hardness and low thermal conductivity.

Uses

It is used for making belts, conveyer belts, etc.

### **c) Asphalt**

It is the residue obtained during the fractional distillation of petroleum.

Uses

1. It is used for water-proofing of roofs.
2. It is used for road making.

## **Synthetic adhesives**

### **Thermoplastic synthetic resins**

Thermoplastic synthetic resins form soluble, fusible and poor water-resistance adhesives. They get softened on heating.

Examples: Cellulose nitrate, PVC, etc.

#### **1) Cellulose nitrate**

Cellulose nitrate is used as a raw material for solvent adhesives. Cellulose nitrate mixed with alcohol is well known as 'colloidon'. The adhesive film developed by cellulose nitrate is tough. But, the adhesive film is inflammable and affected by strong acids and strong alkalies.

Uses

It is used in cloth and foot-wear industry.

#### **2) PVC (Polyvinyl chloride)**

PVC forms hard adhesive films, resistant to atmospheric conditions and chemicals.

Uses

1. It is used for bonding metals, glass, etc.
2. It is used in sealing of food materials.

### **Thermosetting synthetic resins**

Thermosetting synthetic resins have good adhesive properties by forming a network of three dimensional cross-linked structures. The bonding obtained is moisture resistant, heat resistant and fungi proof.

Examples: Phenol-formaldehyde resins, urea-formaldehyde resins, etc.

#### **1) Phenol-formaldehyde resin**

This is pressure sensitive type of adhesive. The adherend surfaces after being coated with this adhesive are subjected to curing by heat and pressure. It is available as solid or liquid form. The bonded film obtained is hard, highly resistant to the action of water, fungi, insects, etc.

## Uses

1. It is used for making water-proof plywoods, laminates, etc.
2. It is used for bonding articles in aircraft and ship building.
3. It is used for bonding wood and metal.
4. It is used for bonding plywood and wooden surfaces.

## 2) Urea-formaldehyde resin

It is a transparent, syrupy compound used in the form of aqueous solution or spray dried powders. The addition of water to this resin helps in forming continuous film with cross linkages and rapid setting properties. The bonded film obtained is resistant to temperature, moisture, etc. It deteriorates by the action of acids and alkalis.

**Uses** (Refer-phenol formaldehyde-uses are same)

1. It is used for bonding plywood and wooden surfaces.
2. It is used for bonding articles in aircraft and ship building.
3. It is used for making water-proof plywoods, laminates, etc.
4. It is used for bonding wood and metal

## Summary

In this lesson, adhesives, their requirements, classification and uses are discussed.

## QUESTIONS

### PART – A

1. Define adhesive.
2. Name two natural adhesives.
3. Name two synthetic adhesives.
4. Mention the uses of shellac.
5. Mention the uses of asphalt.
6. Mention the uses of cellulose nitrate.
7. Mention the uses of PVC.
8. Mention the uses of phenol-formaldehyde.

### PART – B

1. How are adhesives classified? Give examples.
2. Write a note on shellac.
3. Write a note on starch..
4. Write a note on cellulose nitrate.
5. Write a note on PVC.
6. Write a note on phenol-formaldehyde.
7. Write a note on urea-formaldehyde.

### PART – C

1. What are the requirements of a good adhesive?
2. Write a note on the following natural adhesives.  
a. Shellac   b. Starch   c. Asphalt
3. Write a note on the following synthetic adhesives  
a. Cellulose nitrate   b. PVC   c. Phenol-formaldehyde   d. Urea-formaldehyde

## TEST YOUR UNDERSTANDING

Explain the ways by which adhesives develop strength.

## UNIT V

### POLYMERS

#### 5.1 PLASTICS

##### INTRODUCTION

The name plastics or plastic materials in general is given to organic materials of high molecular mass, which can be moulded into any desired form when subjected to heat and pressure in presence of catalysts.

Polymer resin is the basic binding material, which forms the major part of plastics. In the recent years, plastics have attained greater importance in every walk of life due to their unique properties.

Now, plastics substitute all engineering materials like wood, metal, glass, etc. because of their special advantages over other conventional materials.

##### Plastics

**Plastics are organic polymer materials of high molecular mass, which can be moulded into different shapes by using heat and pressure.**

##### Polymerization

Polymerization is the process of converting small, low molecular weight organic molecules into long, high molecular weight organic molecules either by addition reaction or by condensation reaction. The small molecules are called monomers and the products are called polymers.

There are two types of polymerization.

1. Addition polymerization
2. Condensation polymerization

##### 1. Addition polymerization

In this type of polymerization, polymers are formed by simple addition reaction between small molecules containing double or triple bonds.

Example: Formation of polyethylene or polythene.



##### 2. Condensation polymerization

In this type of polymerization, polymers are formed by the reaction between small molecules with elimination of molecules like H<sub>2</sub>O, H<sub>2</sub>S, NH<sub>3</sub>, etc.

Example: Formation of Bakelite

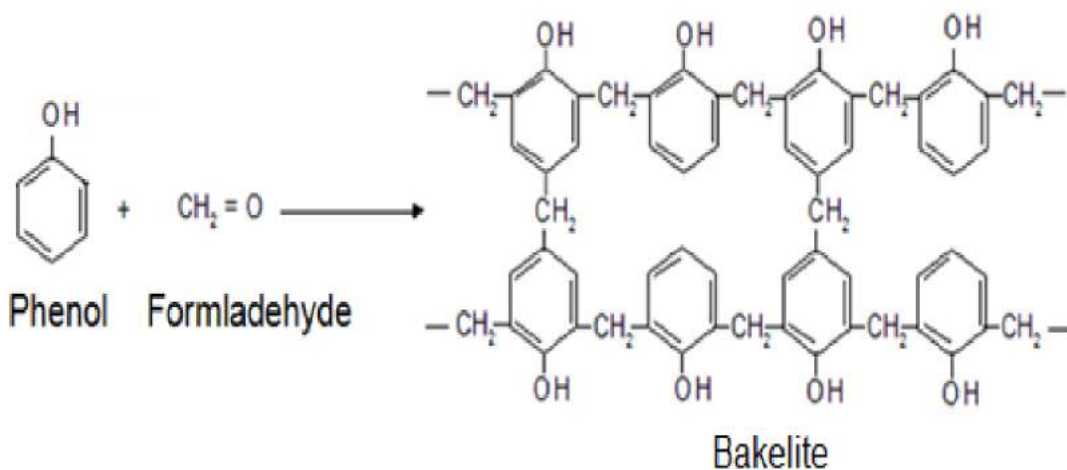

(Phenol-formaldehyde resin)

Bakelite is formed by the condensation reaction between phenol and formaldehyde. This polymer is known as novolac. Water is eliminated as by product.

### Types of plastics

Plastics are classified into two types.

1. Thermoplastics
2. Thermosetting plastics

#### 1. Thermoplastics

They are the resins which soften on heating and set on cooling. Thus, they can be remoulded any number of times and used.

Example: Polythene, PVC, nylon, etc.

#### 2. Thermosetting plastics

They are the resins which set on heating and cannot be resoftened. Hence, their scrap cannot be reused.

Example: Bakelite (Phenol-formaldehyde resin), urea-formaldehyde resin, etc.

## Differences between thermoplastics and thermosetting plastics

The differences between the two types of plastics arise mainly due to the difference in their chemical structure.

Sl. No.	Property	Thermoplastics	Thermosetting plastics
1	Action of heat	They soften on heating and set on cooling every time	They set on heating and cannot be resoftened
2	Type of bonding between adjacent polymer chains	The polymer chains are held together by weak force called Vander Waal's force of attraction	The polymer chains are linked by strong chemical bonds (covalent bonds)
3	Solubility	They are soluble in organic solvents	They are insoluble in organic solvents
4	Expansion due to heating	They expand very much on heating	Their expansion is only marginally on heating
5	Type of polymerization	They are formed by addition polymerization	They are formed by condensation polymerization
6	Type of moulding	They are processed by injection moulding	They are processed by compression moulding
7	Scrap recovery	Scrap can be reused	Scrap cannot be reused
8	Example	Polythene, PVC, nylon	Bakelite

## Mechanical properties of plastics

### 1. Creep or cold flow

Creep is a time dependent continuous deformation of plastics under load. Plastics undergo a change in shape when a load is applied continuously. Creep is due to the displacement of molecules in a polymer structure. Because of this property, plastics cannot be used as load bearing materials.



## **2. Strength to weight ratio**

The stress to strain ratio of a plastic is higher than that of the lightest metals namely Al or Mg. Plastics have good strength when compared to the light weight metals like aluminium, magnesium, etc. Hence, they replace metals like aluminium and magnesium in many fields. Therefore plastics are mainly used for rocket and space ship constructions.

## **3. Thermal stability**

Plastics either degrade or soften at high temperatures. Hence, they cannot be used at high temperatures.

## **4. Softening temperature**

Softening temperature refers to the particular temperature at which a plastic changes from elastic stage to fluid stage. Temperature below which a polymer is hard and above which it is soft is known as 'Glass transition temperature ( $T_g$ ).

## **5. Optical properties**

Some of the plastics are transparent like glass. Hence, they can be substituted for glass in optical instruments.

## **6. Electrical properties**

Plastics are good insulators as they are poor conductors of electricity. So, they are mainly used for electrical insulation purposes.

## **7. Hardness**

Hardness is defined as the resistance of the plastics to penetration, scratching etc. Hardness of plastics can be determined by penetration tests. Thermosetting plastics are hard in nature when compared to thermoplastics.

## **8. Impact strength**

When subjected to suddenly applied load or stress, plastics undergo rupture at a particular load or stress. Impact strength of plastics is measured by tests in which a pendulum is allowed to attack the specimen. Plastics have better impact strength when compared to glass. Hence, they are replacing glasses in many places.

## **9. Tear resistance**

The resistance to tearing is an important property when plastic films are used as packing material. It is measured by using a falling pendulum with a striking edge. Plastics have poor tear resistance

### **Advantages of plastics over other traditional materials (Like wood, metals, glass, etc.)**

1. Plastics are available in attractive colours.
2. They do not undergo corrosion.
3. They are not affected by insects.
4. They are light in weight.
5. They are cheap.
6. They can be moulded into any shape easily.
7. They are chemically inert.
8. They have good abrasion resistance.
9. They are good insulators of heat and electricity.

### **Reinforced plastics or filled plastics**

**The plastics polymers compounded with fillers are called as reinforced or filled plastics.** Physical and mechanical properties of plastics are improved by compounding them with suitable materials. These materials are called fillers and main types of fillers used are silicate materials. Such types of plastics which are reinforced with fillers are called 'Reinforced plastics or filled plastics'.

Most commonly used fillers are

Wood flour, saw dust, ground cork, asbestos, marble flour, china clay, paper pulp, corn husk, mica, pumice powder, carbon, cotton fibres, boron fibres, graphite, silicon carbide, silicon nitride, alumina, glass fibres, metallic oxides like ZnO, PbO, etc. and metallic powders like Al, Cu, Pb, etc.

### **Advantages of filled plastics**

Fillers modify properties of basic polymer. They improve thermal stability, mechanical strength, hardness, desired finish and water resistance. Specific fillers are added to give special characters.

1. They have improved hardness.
2. They are resistant to heat and corrosion.
3. They are impervious to X-rays.
4. They are water resistant.
5. They have high opacity.
6. They have high mechanical and tensile strength.
7. The production cost is low.

## **Applications of filled plastics**

1. Addition of china clay increases the electrical insulation property of PVC.
2. In textiles, for making shutters, filled polymer is used with nylon as polymer.
3. In electrical and electronic industries, filled polymers are used for making exhaust fans, computer tapes, insulators, wire and cable insulation, switch gear parts, etc.(using polypropylene, PET, nylon and SAN as base polymers).
4. In consumer goods like doors, windows, hinges, chairs, camera housing, etc. (polypropylene, ABS are used as base polymers).
5. In defense, for making nose cones, pistol grips and ripple bullets, filled polymers like polystyrene, nylon, etc. are used.
6. They are used in automobiles for making door handles and engine cooling fans.

## **Biomaterials (Polymers in medicine and surgery)**

**Biomaterials are the materials that can be implanted in the body to provide special prosthetic functions and used in diagnostic, surgical and therapeutic applications without causing adverse effect on blood and other tissues.**

Use of polymers as biomaterials is increasing day-by-day, since, many polymers have diverse properties which are more similar to the certain organs of the body. Their appeal and acceptability is mainly due to their versatility and the fact that they are tailor-made or modified at will, suits specific body functions.

Polymers used for medical application should be biocompatible. It should possess the following characteristics.

1. It should have purity and reproducibility.
2. It should have optimum physical and chemical properties.
3. It should be fabricated into any desired shape without being degraded.
4. It should be sterilized easily.
5. Biopolymers that come in contact with blood and tissues should not damage cellular elements of blood, enzymes and proteins.
6. They should not produce toxic and allergic reactions.
7. They should not deplete electrolytes present in the body.

## Biomedical uses of polymers

The mostly used polymers in medical applications are silicone rubber and polyurethane. Polymers used in specific medical applications in medicine are given below.

Sl. No.	Polymer	Applications
1	Polyurethane	Heart valves, blood filters, artificial hearts, vascular tubes, etc.
2	Polyvinyl chloride (PVC)	Disposable syringes, etc.
3	Polypropylene	Heart valves, blood filters, etc.
4	Polyethylene	Disposable syringes, etc.

## Summary

In this lesson, polymerization, types of polymerization, plastics, types of plastics, mechanical properties of plastics, reinforced plastics, its advantages and applications and biomedical applications of plastics are discussed.

### QUESTIONS

#### PART – A

1. What is polymerization?
2. What are the types of polymerization?
3. How polythene is formed?
4. How Bakelite is formed?
5. Define plastic.
6. What are the types of plastics?
7. What are reinforced plastics?
8. What are biomaterials?

#### PART – B

1. Explain addition polymerization with an example
2. Explain condensation polymerization with an example.
3. What are thermoplastics? Give an example.
4. What are thermosetting plastics? Give an example.
5. Mention the advantages of reinforced plastics.
6. Give the applications of reinforced plastics.

#### PART – C

1. List the differences between thermoplastics and thermosetting plastics.
2. Explain the mechanical properties of plastics.
3. What are the advantages of plastics over traditional materials?
4. Write a note on reinforced plastics.
5. What are biomaterials? List the biomedical uses of the following.  
a. Polyurethane b. PVC c. Polypropylene d. Polyethylene

## TEST YOUR UNDERSTANDING

What are the various applications of plastics in our day-to-day life?

## 5.2 RUBBER

### INTRODUCTION

Rubber is a natural elastic polymer of isoprene ( $C_5H_8$ ). It is obtained from the milk of rubber called 'Latex'.

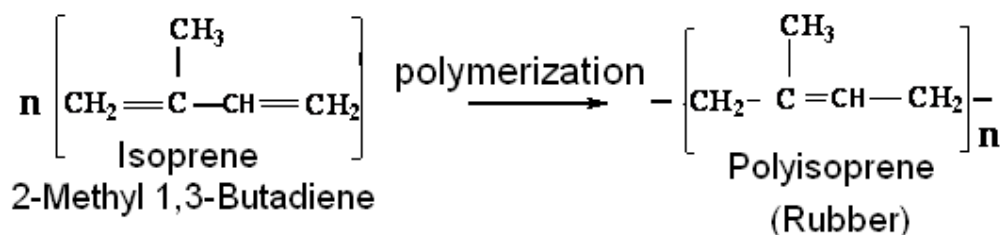

### Preparation of natural rubber from Latex

1. Latex is the rubber milk containing about 30% to 45% rubber.
2. The rubber milk is diluted with water and allowed to stand for some time.
3. The clear liquid from the top is treated with **acetic acid or formic acid** to coagulate the rubber.
4. The coagulated rubber is thoroughly washed with water and then passed through rollers to get sheets of rubber.
5. Rubber sheets are finally dried either in air or in smoke. This rubber is called 'smoked rubber'.
6. During the coagulation of rubber milk with acetic or formic acid, retardants like sodium bisulphite ( $\text{NaHSO}_3$ ) are added to prevent oxidation of rubber. This is called 'Creep rubber'. Thus natural rubber is obtained from latex.

### Defects of natural rubber

The natural rubber obtained from latex cannot be used in industries because it has the following defects.

1. It becomes soft and sticky during summer.
2. It becomes hard and brittle during winter.
3. It swells up in oils.
4. It flows plastically due to prolonged stress.
5. Chemicals easily affect natural rubber.

### Compounding of rubber

Natural rubber is compounded with certain substances to increase the **quality of rubber**.

#### 1. Reinforcing agents or hardeners

They are compounded with natural rubber to give strength to the rubber.

**Example: Carbon powder, zinc oxide, calcium carbonate etc.**

## **2. Softeners**

They are added to make the rubber more soft and elastic.

Example: Vegetable oils, stearic acid, paraffin oil, etc.

## **3. Anti-oxidants**

They are added to prevent destruction of rubber due to aerial oxidation.

Example:  $\beta$ -naphthol, phenol.

## **4. Vulcanization**

**Vulcanization is process of heating the natural rubber with sulphur at 140°C in CO<sub>2</sub> atmosphere. By vulcanization, the hardness of rubber is improved.**

Example: sulphur.

## **5. Pigments (Colouring matter)**

They are added to give different colours to rubber.

Example: Metallic oxides

Zinc oxide	- White
Lead chromate	- Yellow
Chromium oxide	- Green
Carbon black	- Black

## **6. Accelerators**

They are added to speed up the vulcanization reaction of rubber.

Example: Benzothiozole

## **7. Fillers**

Fillers are added to increase the quantity without affecting the quality. The production cost is reduced.

Example: Textile wastes, asbestos, mica, gypsum, talc, etc.

## **Vulcanization of rubber**

- Vulcanization is compounding of rubber with sulphur.
- Vulcanization is process of heating the natural rubber with sulphur at 140°C in CO<sub>2</sub> atmosphere.
- The double bonds present in rubber chain opened and cross linked through sulphur atoms. Hence the vulcanized rubber becomes very hard.
- The hardness of rubber increases as the percentage of sulphur increases. 2 to 4% sulphur addition gives soft elastic rubber. When sulphur content is more than 30%, hard rubber called 'Ebonite' is obtained.

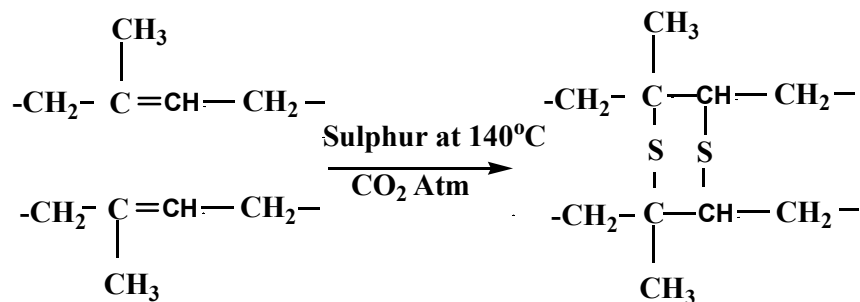

### Properties of vulcanized rubber

1. Vulcanized rubber has very little electrical and thermal conductivity.  
Hence, it is mainly used for electrical insulation purposes.
2. It has high elasticity and tensile strength.
3. Corrosive chemicals and oils do not affect it.
4. It is also not affected by atmosphere.

### Reclaimed rubber

**Rubber prepared from waste rubber articles such as worn out tyres, tubes, gaskets, hoses, foot wears and other rubber wastes is called reclaimed rubber.**

The process of reclamation of rubber is carried out as follows.

1. The waste rubber is cut into small pieces and powdered by using a cracker.
2. Then iron impurities, if any present, is removed by using electromagnetic separator.
3. The purified waste rubber is digested with caustic soda solution at  $200^\circ\text{C}$  under pressure for 8 to 15 hours in 'steam jacked autoclaves'. This process hydrolyses the fibres present in the waste rubber.
4. After the removal of fibres, reclaiming agents like petroleum or coal tar based oils and softeners are added.
5. Sulphur gets removed as sodium sulphide and rubber gets devulcanized.
6. The rubber is thoroughly washed with water spray and dried in hot air driers.
7. Finally, the reclaimed rubber is mixed with small portions of reinforcing agents like clay, carbon black, etc.

### Properties of reclaimed rubber

1. Reclaimed rubber has less tensile strength, low elasticity and possesses very low wear resistance when compared to natural rubber.
2. However, it is much cheaper and has uniform composition.

3. It has better ageing property.
4. It is quite easy for fabrication.

#### **Uses of reclaimed rubber**

1. It is used for the manufacture of tyres, tubes, etc.,
2. It is used for the manufacture of shoes, automobile floor mats, etc.,
3. It is used for the manufacture of hoses.
4. It is used for the manufacture of battery containers.

#### **Summary**

In this lesson, extraction of natural rubber from Latex, defects of natural rubber, compounding of rubber, vulcanization and reclaimed rubber are discussed.

### **QUESTIONS**

#### **PART – A**

1. What is rubber?
2. What is Latex?
3. What is compounding of rubber?
4. What is vulcanization?
5. Define reclaimed rubber.
6. Give any two defects of natural rubber.

#### **PART – B**

1. Give any three defects of natural rubber.
2. Mention the properties of reclaimed rubber.
3. Mention the uses of reclaimed rubber.

#### **PART – C**

1. How natural rubber is obtained from Latex? Explain.
2. What are the defects of natural rubber?
3. What is compounding of rubber? Mention the ingredients and their functions.
4. Explain vulcanization of rubber.
5. What is reclaimed rubber? Explain the process of reclamation of rubber.

#### **TEST YOUR UNDERSTANDING**

What are the various applications of rubber in our day-to-day life?



## 5.3 COMPOSITE MATERIALS

### INTRODUCTION

Each class of basic engineering materials like metals, high polymers and ceramics has its own outstanding and distinct characteristics as well as laminates. However very stringent requirements of supersonic aircraft, gas turbines and high temperature reactors have forced to develop a new class of materials called “composites”.

The composite materials are generally made by placing the dissimilar materials together in such a manner that they work as a single mechanical unit. The properties of new materials so produced are different in kind and scale from those of any constituents. Thus, it has become possible to incorporate or alter properties, more than that, introduces a combination of properties like high strength and stiffness at elevated temperatures.

Metals for instance, lose their strength at elevated temperatures. High polymeric materials in general can withstand still lower temperatures. Ceramics, due to their brittleness are unsatisfactory structural materials. This led to the exploration of combination of metals and polymers with ceramics resulting in composites having required properties which seems to be the hope for the future.

#### **Composite material**

A composite material contains two phases namely

1. Matrix phase
2. Dispered phase.

#### **Matrix phase:**

A continuous body constituent which encloses the composite and gives a bulk form is called matrix phase.

The matrix acts as a medium which protects and binds the dispersed phase.

The matrix phase may be metals, ceramics or polymers.

#### **Dispersed phase:**

The substance which is dispersed in the matrix phase is called the dispersed phase. It constitutes the internal structure of the composite.

#### **Definition:**

**A multiphase material consisting of a mixture of two (or) more substances with different properties which are mutually insoluble is called as Composite material.**

**Concrete is the best example for composite.**

Thus, using composites it is possible to have such combination of properties like high strength and stiffness, corrosion resistance and ability to withstand extreme high temperature conditions.

## Examples

1. Wood (A composite of cellulose fibres and lignin cementing materials)
2. Rain proof cloth (A cloth impregnated with water-proof material)
3. Bone (A composite of soft collagen and brittle and hard material apatite)

## Advantageous properties of composite materials over metals and polymers

The important advantages of composite materials over metals and polymers are given below.

1. Higher specific strength.
2. Lower specific gravity.
3. Higher specific stiffness.
4. Lower electrical conductivity.
5. Better corrosion and oxidation resistance.
6. Good impact and thermal shock resistance.
7. Can be fabricated easily.

## General applications of composite materials

1. In fabrication of roof and floors.
2. In aeronautical applications like components of rockets, aircrafts, helicopters, etc.
3. In valves, pump parts, spray nozzles, etc.
4. In communication antennae, electronic circuit boards, etc.
5. In marine applications like propellers, shaft, hulls and other ship parts.
6. In automobile industries, turbine engines, etc.

## Summary

In this lesson, advantages and applications of composite materials are discussed.

## QUESTIONS

### PART – A

1. What are composite materials?
2. Give examples for composite materials.

### PART – B

1. Write any three advantages of composite materials over metals and polymers.
2. Mention any three applications of composite materials.

### PART – C

1. Write a note on advantages of composite materials over metals and polymers.
2. Mention the applications of composite materials.

## TEST YOUR UNDERSTANDING

How are composite materials prepared?

**ENGINEERING CHEMISTRY**  
**PRACTICAL- II (30028)**  
**SEMESTER- II**  
**QUALITATIVE ANALYSIS**

Simple qualitative analysis involves the identification of the constituent of an inorganic substance or a mixture of substances. A simple inorganic salt is made up of two radicals. They are acid and basic radicals. The inorganic substances are split up into two types of charged particles one of which is positively charged and the other is negatively charged. The charged particle is called ion or radical. The acid radical is of negatively charged one and is called as anion. The basic radical is of positively charged one and is called as cation.

In the qualitative analysis of an inorganic substance number of test are systematically carried out in order to discover the acidic and basic radical present in it. A test is an experiment along with an observation made to show the presence or absence of certain substance or class of substances. In the test we note the formation or disappearance of 1). A Colour or 2).A precipitate or 3). A gas or 4). An odour.

Hence the qualitative analysis involves three simultaneous process. They are

1. Experiment
2. Observation
3. Inference.

The test may be positive or negative. A positive test is one that gives the result indicated in the procedure and shows the presence of the particular radical. A negative test is one which does not give the indicated results and shows the absence of the particular radical. The substances or solutions are added to bring about the reactions are called Reagents.

Finally the students have to analyze the given simple salt in systematic manner and report the salt and the radicals present in it.

**Acid Radicals** : Carbonate, Chloride, Nitrate and Sulphate.

**Basic Radicals** : Lead, Copper, Aluminium, Zinc, Barium, Calcium, Magnesium and Ammonium.

**STATE BOARD OF TECHNICAL EDUCATION & TRAINING, TAMILNADU**  
**DIPLOMA IN ENGINEERING / TECHNOLOGY SYLLABUS**  
**M-SCHEME**  
**(Implements from the Academic year 2015 - 2016 onwards)**

Course Name: All Branches of Diploma in Engineering and Technology and Special

Programmes except DMOP, HMCT and Film & TV

Subject Code: **30028**

Semester : II Semester

Subject Title: **ENGINEERING CHEMISTRY – II PRACTICAL**

**SCHEME OF INSTRUCTIONS AND EXAMINATION:**

**No. of Weeks per Semester: 15 Weeks**

Subject	Instructions		Examination			
	Hours / Week	Hours/ Semester	Marks			Duration
			Internal Assessment / Record	Board Examination	Total	
ENGINEERING CHEMISTRY - II PRACTICAL	2	30	25	75	100	3 Hours

**OBJECTIVES:**

1. At the end of the program the student will be able to identify the acid and basic radical present in the given Inorganic simple salt.
2. To analyse the given effluent and to find out presence of heavy metal ion present it.
3. To study about the harmful effects of the metallic pollutant.

**INTERNAL ASSESSMENT/RECORD : 25 MARKS**  
**BOARD EXAMINATION : 75 MARKS**

FOR	MARKS
ANALYSIS OF SIMPLE	46
ANALYSIS OF EFFLUENT	24
VIVA-VOCE	05
TOTAL	75

## ENGINEERING CHEMISTRY – II PRACTICAL

### CONTENTS

#### Intellectual Skills

1. Studying the effect of heating on substances and reagents
2. Study of the reactions of the following radicals leading to qualitative analysis of the given Inorganic simple salt soluble in water or dilute acids
3. Studying the harmful effects of effluents

**Acid Radicals** : Carbonate, Chloride, Nitrate and Sulphate

**Basic Radicals** : Lead, Copper, Aluminium, Zinc, Barium, Calcium, Magnesium and Ammonium

#### Motor Skills

1. Handling the apparatus carefully
2. Awareness on Industrial safety

#### **I. Analysis of Inorganic simple salt (QUALITATIVE ANALYSIS)**

Analysis of eight inorganic simple salts containing any one acid radical and basic radical without omitting any of the above mentioned radicals.

#### **II. Analysis of Effluent containing Lead, Cadmium, Copper and Zinc metal ions (EFFLUENT ANALYSIS)**

Analysis of four effluents, each containing the above mentioned metal ions. Report on the metallic pollutant with procedure (Basic Radical Analysis Procedure) and their harmful effects.

#### **MODEL QUESTION PAPER**

**3 Hours**

1. Analyse the given Inorganic simple salt and report the acid radical and basic radical present in it.
2. Analyse the given sample of effluent and report the metallic pollutant present in it with procedure and its harmful effects.

**Note: All the students are the given same question and each batch of student is given different inorganic simple salt and effluent. (Eight salt and four effluents).**

#### **SCHEME OF EVALUATION**

FOR	MARKS
ANALYSIS OF SIMPLE SALT	46
ANALYSIS OF EFFLUENT	24
VIVA-VOCE	05
TOTAL	75

## I. QUALITATIVE ANALYSIS:

FOR	MARKS
Identification of Acid Radical with Systematic Procedure	23
Identification of Basic Radical with Systematic Procedure	23

\*

Identification of Acid Radical with confirmatory test	10
Identification of Basic Radical with confirmatory test	10
Mere Spotting of Acid Radical and Basic Radical (3+3)	06

## II. EFFLUENT ANALYSIS:

FOR	MARKS
Identification of metallic pollutant with systematic procedure	20
Harmful effects of metallic pollutant	04

\*

Group Identification Tests of metallic pollutant	10
Confirmatory Test of metallic pollutant	10
Mere Spotting of the pollutant	03

**List of Apparatus to be provided for each student in Chemistry Laboratory during the Engineering Chemistry – II Practical Classes/Board Examination in addition to the required Reagents:**

Sl.No.	Name of the Item	Quantity (Nos.)
1	Funnel	1
2	Glass Rod	1
3	Test Tubes (15 x 1.5 mm)	4
4	Test Tubes (15 x 1.5 mm)	1
5	Test Tube cleaning Brush	1
6	Test Tube Holder	1
7	Test Tube Stand	1
8	Wash Bottle	1

## FIRST YEAR ENGINEERING CHEMISTRY LABORATORY

### LIST OF EQUIPMENTS

#### LIST OF EQUIPMENTS REQUIRED FOR A BATCH OF 30 STUDENTS NON-CONSUMABLE ITEMS

Sl.No.	Name of the Item	Quantity (Nos.)
1	LPG Connection	
2	Exhaust Fan (High Capacity)	Sufficient Nos.
3	Fire Extinguisher	1
4	First Aid Box (Full Set)	2
5	Safety Chart	1
6	Chemical Balance	1
7	Fractional Weight Box	1
8	pH Meter	5
9	Working Table with all accessories	8

#### GLASSWARE AND OTHER ITEMS

Sl.No.	Name of the Item	Quantity (Nos.)
1	Burette (50 ml)	35
2	Burette Stand	35
3	Pipette (20 ml) (With safety Bulb)	35
4	Pipette (10 ml)	5
5	Conical Flask (250 ml)	35
6	Funnel (3")	50
7	Porcelain Tile	35
8	Measuring Cylinder (10 ml)	5
9	Measuring Cylinder (1000 ml)	2
10	Reagent Bottle (White) (250 ml)	60
11	Reagent Bottle (White) (125 ml)	100
12	Reagent Bottle (Amber) (250 ml)	80
13	Test Tube (15 mm x 1.5 mm)	1000
14	Test Tube (15 mm x 2.5 mm)	500
15	Test Tube Stand	35
16	Test Tube Holder	35
17	Test Tube cleaning brush	35
18	Glass Trough	5
19	Beaker (100 ml)	35
20	Glass Rod (15 cm)	100
21	Watch Glass (3")	35
22	Wash Bottle (Polythene)	35
23	Nickel Spatula	35
24	Bunsen Burner for Gas connection	35
25	Plastic Bucket (15 L)	10
26	Filter Papers (Round)	Sufficient Nos.
27	Standard Flask (100 ml)	35

**SYSTEMATIC ANALYSIS OF THE GIVEN INORGANIC SIMPLE SALT**

Sl. No.	EXPERIMENT	OBSERVATION	INFERENCE
<b>A. PRELIMINARY DRY REACTIONS</b>			
1	<b>COLOUR</b> The colour of the given salt is noted.	a. Blue or bluish green b. White	May be Copper Absence of Copper
2	<b>APPEARANCE</b> Appearance of the given salt is noted.	a. Amorphous b. Crystalline	May be Carbonate Absence of Carbonate
3	<b>SOLUBILITY</b> <b>In dilute HCl acid</b> A little of the given salt is dissolved in dilute hydrochloric acid in a test tube. <b>In water</b> A little of the given salt is dissolved in distilled water in a test tube.	a. Soluble b. Insoluble a. Insoluble b. Soluble	Absence of Lead May be Lead May be Carbonate Absence of Carbonate
4	<b>ACTION OF HEAT</b> A little of the given salt is strongly heated in a dry test tube.	a. A white sublimate is formed b. Yellow when hot and white when cold c. Orange red when hot and yellow when cold d. Reddish brown vapours are evolved e. Blue changes to white f. No characteristic change	May be Ammonium May be Zinc May be Lead May be Nitrate May be Copper Absence of Ammonium, Zinc, Lead, Nitrate and Copper



5	<b>FLAME TEST</b> The paste of the given salt with concentrated hydrochloric acid is introduced into a non-luminous part of the flame and the colour is noted.	a. Bluish green coloured flame b. Brick red coloured flame c. Pale green coloured flame d. No characteristic coloured flame	May be Copper May be Calcium May be Barium Absence of Copper, Calcium and Barium
<b>B. WET REACTIONS</b>			
<b>Sl. No.</b>	<b>EXPERIMENT</b>	<b>OBSERVATION</b>	<b>INFERENCE</b>
6	<b>ACTION OF dil. HCl</b> To a pinch of the salt taken in a test tube dilute hydrochloric acid is added.	a. A colourless gas with brisk effervescence turning lime water milky is evolved b.No characteristic gas	Presence of Carbonate is confirmed Absence of Carbonate
7	<b>ACTION OF Conc. H<sub>2</sub>SO<sub>4</sub></b> To a little of the salt taken in a test tube few drops of concentrated sulphuric acid is added and warmed.	a. A colourless pungent smelling gas giving dense white fumes with a glass rod dipped in ammonium hydroxide is evolved b.Brown vapours are evolved C.No characteristic reaction	May be Chloride May be Nitrate Absence of Chloride and Nitrate
8	<b>ACTION OF Conc. H<sub>2</sub>SO<sub>4</sub> AND COPPER TURNINGS</b> To a small amount of the given salt a bit of copper turnings and a few drops of concentrated sulphuric acid are added and heated.	a. Copious evolution of brown vapours b. No brown vapours	May be Nitrate Absence of Nitrate

9	<p><b>ACTION OF Conc. H<sub>2</sub>SO<sub>4</sub> AND MnO<sub>2</sub></b></p> <p>To a small amount of the given salt a pinch of manganese dioxide and a few drops of concentrated sulphuric acid are added and warmed.</p>	<p>a. A greenish yellow gas is evolved</p> <p>b. No characteristic gas</p>	<p>May be Chloride</p> <p>Absence of Chloride</p>
10	<p><b>CHROMYL CHLORIDE TEST</b></p> <p>To a small amount of the given salt few crystals of potassium dichromate and few drops of concentrated sulphuric acid are added and warmed.</p>	<p>a. Reddish brown vapours giving yellow precipitate with a glass rod dipped in lead acetate solution are evolved.</p> <p>b. No reddish brown vapours</p>	<p>May be Chloride</p> <p>Absence of Chloride</p>

Sl. No.	EXPERIMENT	OBSERVATION	INFERENCE
<p><b>C. REACTIONS USING SODIUM CARBONATE EXTRACT</b></p> <p><b>Preparation of Sodium Carbonate Extract</b></p> <p>A mixture of one part of the given salt and three parts of solid sodium carbonate is boiled with distilled water and filtered. The filtrate is called sodium carbonate extract.</p>			
11	<p><b>BARIUM CHLORIDE TEST</b></p> <p>To a little of the extract dilute hydrochloric acid is added till the effervescence ceases and then barium chloride solution is added.</p>	<p>a. A white precipitate insoluble in concentrated hydro-chloric acid is obtained</p> <p>b. No white precipitate</p>	<p>Presence of Sulphate is confirmed</p> <p>Absence of Sulphate</p>
12	<p><b>LEAD ACETATE TEST</b></p> <p>To a little of the extract dilute nitric acid is added till the effervescence ceases and then lead acetate solution is added.</p>	<p>a. A white precipitate is obtained</p> <p>b. No white precipitate</p>	<p>Presence of Sulphate is confirmed</p> <p>Absence of Sulphate</p>

13	<b>SILVER NITRATE TEST</b> To a little of the extract dilute nitric acid is added till the effervescence ceases and then silver nitrate solution is added.	a. A curdy white precipitate soluble in ammonium hydroxide is obtained b.No white precipitate	Presence of Chloride is confirmed  Absence of Chloride
14	<b>BROWN RING TEST</b> To a little of the extract dilute sulphuric acid is added till the effervescence ceases. To this freshly prepared ferrous sulphate solution is added and then concentrated sulphuric acid is added through the sides of the test tube.	a. Brown ring is formed at the junction of two liquids b.No brown ring	Presence of Nitrate is confirmed  Absence of Nitrate

#### D. IDENTIFICATION OF BASIC RADICALS

##### Preparation of original solution

The original solution is prepared by dissolving the given salt in distilled water/dilute hydrochloric acid/dilute nitric acid.

#### GROUP SEPARATION

Sl. No.	EXPERIMENT	OBSERVATION	INFERENCE
1	To a little of the original solution dilute hydrochloric acid is added.	a. A white precipitate is obtained b.No white precipitate	Presence of I Group Radical (Lead)  Absence of I Group Radical
2	To a little of the original solution dilute hydrochloric acid and yellow ammonium sulphide are added.	a.A black precipitate is obtained b.A yellow precipitate is obtained c.No characteristic precipitate	Presence of II Group Radical (Copper) Presence of II Group Radical (Cadmium) Absence of II Group Radical
3	To a little of the original solution ammonium chloride and ammonium hydroxide solutions are added.	a.A gelatinous white precipitate is obtained b.No white precipitate	Presence of III Group Radical (Aluminium)  Absence of III Group Radical

4	To a little of the original solution ammonium chloride and ammonium hydroxide solutions are added. Then hydrogen sulphide gas is passed through the solution.	a.A white precipitate is obtained  b.No white precipitate	Presence of IV Group Radical (Zinc)  Absence of IV Group Radical
5	To a little of the original solution ammonium chloride, ammonium hydroxide and ammonium carbonate solutions are added.	a.A white precipitate is obtained  b.No white precipitate	Presence of V Group Radical (Barium or Calcium)  Absence of V Group Radical
6.	To a little of the original solution ammonium chloride, ammonium hydroxide and disodium hydrogen phosphate solutions are added.	a.A white precipitate is obtained  b.No white precipitate	Presence of VI Group Radical (Magnesium)  Absence of VI Group Radical
7	To a small amount of the salt sodium hydroxide solution is added and heated.	A colourless gas giving dense white fumes with a glass rod dipped in concentrated hydrochloric acid is evolved	Presence of Zero Group Radical (Ammonium)
<b>CONFIRMATORY TESTS FOR BASIC RADICALS</b>			
<b>LEAD – GROUP I</b>			
1	To a little of the original solution potassium chromate solution is added.	A yellow precipitate is obtained	Presence of Lead is confirmed
2	To a little of the original solution potassium iodide solution is added.	A yellow precipitate is obtained	Presence of Lead is confirmed
3	The above yellow precipitate is dissolved in hot water and cooled under tap water.	Golden yellow spangles are obtained	Presence of Lead is confirmed

<b>COPPER – GROUP II</b>			
1	To a little of the original solution ammonium hydroxide solution is added.	A pale blue precipitate is obtained	Presence of Copper is confirmed
2	To the pale blue precipitate excess of ammonium hydroxide solution is added.	The precipitate dissolves in excess of ammonium hydroxide and forms a deep blue solution	Presence of Copper is confirmed
3	To a little of the original solution potassium ferrocyanide solution is added.	A chocolate brown precipitate is obtained	Presence of Copper is confirmed
<b>ALUMINIUM – GROUP III</b>			
1	To a little of the original solution sodium hydroxide is added (drop by drop to excess).	A white precipitate soluble in excess of sodium hydroxide is obtained	Presence of Aluminium is confirmed
Sl. No.	EXPERIMENT	OBSERVATION	INFERENCE
<b>ZINC – GROUP IV</b>			
1	To a little of the original solution potassium ferrocyanide solution is added.	A white precipitate is obtained	Presence of Zinc is confirmed
2	<b>Green ash Test</b> To a little of the original solution (fairly conc. solution) few drops of dilute nitric acid and cobalt nitrate solutions are added. A filter paper is soaked in this solution and burnt in a blue flame.	Green ash is obtained	Presence of Zinc is confirmed
<b>BARIUM – GROUP V</b>			
1	To a little of the original solution dilute sulphuric acid is added.	A white precipitate is obtained	Presence of Barium is confirmed

2	To a little of the original solution acetic acid and potassium chromate solutions are added.	A yellow precipitate is obtained	Presence of Barium is confirmed
<b>CALCIUM – GROUP V</b>			
1	To a little of the original solution ammonium chloride, ammonium hydroxide and ammonium oxalate solutions are added.	A white precipitate is obtained	Presence of Calcium is confirmed
<b>MAGNESIUM – GROUP VI</b>			
1	To a little of the original solution sodium hydroxide is added (drop by drop to excess).	A white precipitate insoluble in excess of sodium hydroxide is obtained.	Presence of Magnesium is confirmed.
2	To a little of the original solution Magneson reagent is added.	A blue precipitate is obtained.	Presence of Magnesium is confirmed.
<b>AMMONIUM – GROUP ZERO</b>			
1	To a little of the original solution Nessler's reagent is added.	A brown precipitate is obtained	Presence of Ammonium is confirmed

## MODEL ANALYSIS – AMMONIUM SULPHATE

Sl. No.	EXPERIMENT	OBSERVATION	INFERENCE
<b>A. PRELIMINARY DRY REACTIONS</b>			
1	<b>COLOUR</b> The colour of the given salt is noted.	White	Absence of Copper
2	<b>APPEARANCE</b> Appearance of the given salt is noted	Crystalline	Absence of Carbonate
3	<b>SOLUBILITY</b>		
a	In dilute hydrochloric acid A little of the given salt is dissolved in dilute hydrochloric acid in a test tube.	Soluble	Absence of Lead
b	In water A little of the given salt is dissolved in distilled water in a test tube.	Soluble	Absence of Carbonate
4	<b>ACTION OF HEAT</b> A little of the given salt is strongly heated in a dry test tube.	A white sublimate is formed	May be Ammonium
<b>B. WET REACTIONS</b>			
6	<b>ACTION OF dil. HCl</b> To a pinch of the salt taken in a test tube dilute hydrochloric acid is added.	No characteristic gas	Absence of Carbonate
7	<b>ACTION OF Conc. H<sub>2</sub>SO<sub>4</sub></b> To a little of the salt taken in a test tube few drops of concentrated sulphuric acid is added and warmed.	No characteristic reaction	Absence of Chloride and Nitrate
8	<b>ACTION OF Conc. H<sub>2</sub>SO<sub>4</sub> AND COPPER TURNINGS</b> To a small amount of the given salt a bit of copper turnings and a few drops of concentrated sulphuric acid are added and heated.	No brown vapours	Absence of Nitrate

9	<b>ACTION OF Conc. H<sub>2</sub>SO<sub>4</sub> AND MnO<sub>2</sub></b> To a small amount of the given salt a pinch of manganese dioxide and a few drops of concentrated sulphuric acid are added and warmed.	No characteristic gas	Absence of Chloride
10	<b>CHROMYL CHLORIDE TEST</b> To a small amount of the given salt few crystals of potassium dichromate and few drops of concentrated sulphuric acid are added and warmed.	No reddish brown vapours	Absence of Chloride

### C. REACTIONS USING SODIUM CARBONATE EXTRACT

#### Preparation of Sodium Carbonate Extract

A mixture of one part of the given salt and three parts of solid sodium carbonate is boiled with distilled water and filtered. The filtrate is called sodium carbonate extract.

SI. No	EXPERIMENT	OBSERVATION	INFERENCE
12	<b>LEAD ACETATE TEST</b> To a little of the extract dilute nitric acid is added till the effervescence ceases and then lead acetate solution is added.	A white precipitate is obtained	Presence of Sulphate is confirmed
13	<b>SILVER NITRATE TEST</b> To a little of the extract dilute nitric acid is added till the effervescence ceases and then silver nitrate solution is added.	No white precipitate	Absence of Chloride
14	<b>BROWN RING TEST</b> To a little of the extract dilute sulphuric acid is added till the effervescence ceases. To this freshly prepared ferrous sulphate solution is added and then concentrated sulphuric acid is added through the sides of the test tube.	No brown ring	Absence of Nitrate



### D. IDENTIFICATION OF BASIC RADICALS

#### Preparation of original solution

The original solution is prepared by dissolving the given salt in distilled water.

#### GROUP SEPARATION

1	To a little of the original solution dilute hydrochloric acid is added.	No white precipitate	Absence of I Group Radical
2.	To a little of the original solution dilute hydrochloric acid and yellow ammonium sulphide are added.	No characteristic precipitate	Absence of II Group Radical
3	To a little of the original solution ammonium chloride and ammonium hydroxide solutions are added.	No white precipitate	Absence of III Group Radical
4	To a little of the original solution ammonium chloride and ammonium hydroxide solutions are added. Then hydrogen sulphide gas is passed through the solution.	No white precipitate	Absence of IV Group Radical
5	To a little of the original solution ammonium chloride, ammonium hydroxide and ammonium carbonate solutions are added.	No white precipitate	Absence of V Group Radical
6	To a little of the original solution ammonium chloride, ammonium hydroxide and disodium hydrogen phosphate solutions are added.	No white precipitate	Absence of VI Group Radical

7	To a small amount of the salt sodium hydroxide solution is added and heated.	A colourless gas giving dense white fumes with a glass rod dipped in concentrated hydrochloric acid is evolved	Presence of Zero Group Radical (Ammonium)
<b>E. CONFIRMATORY TEST FOR ACID RADICAL - SULPHATE</b>			
1	<b>BARIUM CHLORIDE TEST</b> To a little of the extract dilute hydrochloric acid is added till the effervescence ceases and then barium chloride solution is added.	A white precipitate insoluble in concentrated hydrochloric acid is obtained	Presence of Sulphate is confirmed
<b>F. CONFIRMATORY TEST FOR BASIC RADICAL - AMMONIUM</b>			
1	To a little of the original solution Nessler's reagent is added.	A brown precipitate is obtained	Presence of Ammonium is confirmed

## RESULT

1. Acid Radical: Sulphate
2. Basic Radical: Ammonium
3. The given salt is Ammonium sulphate

## ANALYSIS OF EFFLUENTS CONTAINING METALLIC POLLUTANTS

### (LEAD, COPPER, CADMIUM AND ZINC)

#### IDENTIFICATION OF BASIC RADICAL IN EFFLUENT

SI. No	EXPERIMENT	OBSERVATION	INFERENCE
01	To a little of the effluent dilute hydrochloric acid is added.	a. A white precipitate is obtained b. No white precipitate	Presence of Lead Absence of Lead
02	To a little of the effluent dilute hydrochloric acid is added. Then hydrogen sulphide gas is passed through the solution.	a. A black precipitate is obtained. b. A yellow precipitate is obtained. c. No characteristic precipitate	Presence of Copper Presence of Cadmium Absence of Copper and Cadmium
03	To a little of the effluent ammonium chloride and ammonium hydroxide solutions are added. Then hydrogen sulphide gas is passed through the solution.	a. A white precipitate is obtained. b. No white precipitate	Presence of Zinc Absence of Zinc

SI. No	EXPERIMENT	OBSERVATION	INFERENCE
<b>CONFIRMATORY TESTS FOR METALLIC POLLUTANTS</b>			
<b>LEAD</b>			
01	To a little of the effluent potassium chromate solution is added.	A yellow precipitate is obtained	Presence of Lead is confirmed
02	To a little of the effluent potassium iodide solution is added.	A yellow precipitate is obtained	Presence of Lead is confirmed
03	The above yellow precipitate is dissolved in hot water and cooled under tap water.	Golden yellow spangles are obtained	Presence of Lead is confirmed

<b>COPPER</b>				
01	To a little of the effluent ammonium hydroxide solution is added.	A pale blue precipitate is obtained	Presence of Copper confirmed	of is
02	To the pale blue precipitate excess of ammonium hydroxide solution is added.	The precipitate dissolves in excess of ammonium hydroxide and forms a deep blue solution	Presence of Copper confirmed	of is
03	To a little of the effluent potassium ferrocyanide solution is added.	A chocolate brown precipitate is obtained	Presence of Copper confirmed	of is
<b>CADMIUM</b>				
01	To a little of the effluent dilute hydrochloric acid is added. Then hydrogen sulphide gas is passed through the solution.	A yellow precipitate is obtained.	Presence of Cadmium	of
<b>ZINC</b>				
01	To a little of the effluent potassium ferrocyanide solution is added.	A white precipitate is obtained	Presence of Zinc is confirmed	
02	Green ash Test To a little of the effluent (fairly concentrated) few drops of dilute nitric acid and cobalt nitrate solutions are added. A filter paper is soaked in this solution and burnt in a blue flame.	Green ash is obtained	Presence of Zinc is confirmed	

## HARMFUL EFFECTS OF METALLIC POLLUTANTS

### Harmful effects of Lead

1. Affects liver and kidney
2. Causes nervous disorder
3. Produce mental retardation in children
4. Produce gastro-intestinal damage
5. Causes loss of appetite

### Harmful effects of Copper

1. Severely affect the digestive system
2. Causes vomiting and diarrhea
3. Affects blood, bone and teeth
4. It is toxic to aquatic life
5. Causes cancer and tuberculosis

### Harmful effects of Cadmium

1. Causes kidney damage
2. Affects liver
3. Produce anemia and hypertension
4. Produce gastro-intestinal damage
5. Causes vomiting and diarrhea

### Harmful effects of Zinc

1. Affects skin
2. Causes vomiting and diarrhea
3. Causes irritation
4. Causes dizziness and itching
5. Causes nausea

## MODEL QUESTION PAPER

1. Analyse the given Inorganic simple salt and report the acid radical and basic radical present in it.
2. Analyse the given sample of effluent and report the metallic pollutant present in it with procedure and its harmful effects.

### MODEL ANALYSIS OF AN EFFLUENT

Sl. No	EXPERIMENT	OBSERVATION	INFERENCE
1	To a little of the effluent dilute hydrochloric acid is added.	A white precipitate is obtained	Presence of Lead
2	To a little of the effluent dilute hydrochloric acid is added. Then hydrogen sulphide gas is passed through the solution.	No characteristic precipitate	Absence of Copper and Cadmium
3	To a little of the effluent ammonium chloride and ammonium hydroxide solutions are added. Then hydrogen sulphide gas is passed through the solution.	No white precipitate	Absence of Zinc
<b>CONFIRMATORY TESTS FOR LEAD- GROUP I</b>			
1	To a little of the effluent potassium chromate solution is added.	Yellow precipitate is obtained	Presence of Lead is confirmed
2	To a little of the effluent potassium iodide solution is added.	Yellow precipitate is obtained	Presence of Lead is confirmed
3	The above yellow precipitate is dissolved in hot water and cooled under tap water.	Golden yellow spangles are obtained	Presence of Lead is confirmed

### REPORT

The metallic pollutant present in the given Effluent is Lead.

#### **Harmful effects of Lead**

1. Affects liver and kidney
2. Causes nervous disorder
3. Produce mental retardation in children
4. Produce gastro-intestinal damage
5. Causes loss of appetite

## 2.MODEL ANALYSIS OF AN EFFLUENT

SI.No.	EXPERIMENT	OBSERVATION	INFERENCE
01	To a little of the effluent dilute hydrochloric acid is added.	No white precipitate	Absence of Lead
02	To a little of the effluent dilute hydrochloric acid is added. Then hydrogen sulphide gas is passed through the solution.	A black precipitate is obtained.	Presence of Copper
03	To a little of the effluent ammonium chloride and ammonium hydroxide solutions are added. Then hydrogen sulphide gas is passed through the solution.	No white precipitate	Absence of Zinc
SI.No.	EXPERIMENT	OBSERVATION	INFERENCE
<b>CONFIRMATORY TESTS FOR METALLIC POLLUTANTS</b>			
<b>COPPER</b>			
01	To a little of the effluent ammonium hydroxide solution is added.	A pale blue precipitate is obtained	Presence of Copper is confirmed
02	To the pale blue precipitate excess of ammonium hydroxide solution is added.	The precipitate dissolves in excess of ammonium hydroxide and forms a deep blue solution	Presence of Copper is confirmed
03	To a little of the effluent potassium ferrocyanide solution is added.	A chocolate brown precipitate is obtained	Presence of Copper is confirmed

### REPORT

The metallic pollutant present in the given Effluent is **Copper**.

#### Harmful effects of Copper

1. Severely affect the digestive system
2. Causes vomiting and diarrhea
3. Affects blood, bone and teeth
4. It is toxic to aquatic life
5. Causes cancer and tuberculosis

## FIRST AID FOR ACCIDENTS IN CHEMISTRY LABORATORIES

ACCIDENT	FIRST AID TREATMENT
<b>1. FIRE</b> (a). Inflammable gases, liquids on fire.	i Pour water carefully. except when sodium, potassium, oil, spirit is on fire
	ii Throw large quantities of sand if sodium, etc. is on fire.
	iii Throw a mixture of sand and sodium-bicarbonate if oil or spirit is on fire.
	iv If any liquid or flask has caught fire, cover the mouth of the vessel with a damp cloth or duster
	v Cover with a piece of blanket or thick cloth or card-board.
(b). Burning of clothes.	i Lay the person on the floor, burning parts of cloth upwards and cover with a blanket. Never throw water on the person; otherwise it will cause serious boils on the body.
<b>2. Cuts</b>	Remove the visible glass pieces, etc. if any from the affected part. Stop bleeding by one of the following methods  (i) By applying pressure at the place of injury.  (ii) By washing with alum or $\text{FeCl}_3$ solution.  (iii) By applying a little spirit or dettol on the skin and cover with a piece of leucoplast
<b>3. BURNS</b> (a) By dry heat (i.e., flame, steam, hot object, etc.)	1 i) Avoid handling the affected area as far as possible. Do not break the blisters. For minor burns apply burnol and sarson oil (mustard oil).  ii) Cover the affected part with lint or linen saturated with carron oil (a mixture of linseed oil and lime water in equal amounts) or with cold cream, etc. and bandage tightly
	(b) By corrosive acids.



		with water. If burning persists wipe the skin with cotton wool and apply burnol and sarson oil.
(c) By corrosive alkalis.		Wash immediately with excess of water, then with dilute acetic acid or lemon juice and apply burnol or sarson oil dressing
(d) By bromine.	i	Wash with petrol or alcohol and then rub glycerine. Finally smear with burnol.
	ii	Wash with dil. $\text{Na}_2\text{CO}_3$ solution (1:10); then with alcohol and picric acid and apply oil dressing
<b>4..EYE INJURIES</b> a. a) By acid.		Wash with excess of water, then with 3% $\text{NaHCO}_3$ and then with excess of water, forcibly opening the eyes. If necessary, drop castor oil (mobile oil) into the eyes, cover with cotton wool and bandage lightly
(b) By alkalis.		Wash well with 2% boric acid solution; the best as in (a).
( c) By bromine or chlorine vapour.		Wash with dil. $\text{NaHCO}_3$ solution and then bring near the eyes a cloth or sponge soaked in alcohol or alcohol + ether mixture. Do not allow the liquid to enter the eyes
(d) By foreign particles.		Wash it by sprinkling water into the eyes. Open the eye carefully and remove the particle by means of cotton wool or clean handkerchief. Wash again with water. Then put a drop olive or castor oil in the eyes and keep closed
<b>5.DAMAGE TO CLOTHES</b> (a) By acids.	1	Apply $(\text{NH}_4)_2\text{CO}_3$ solution or dilute ammonia and wash well with water
(b) By alkalis.	2	Apply lemon juice or dil. acetic acid, wash well with plenty of water
<b>6.POISONING</b> (a) Strong acids.	1	Give plenty of water. Then give 2 tablespoons of lime water or milk of magnesia.
(b) Caustic alkalis.	2	Give plenty of water. Then give orange or lemon juice.

( c) Salts of heavy metal or copper sulphate.	3	Give milk or white of an egg.
(d) Mercury salts.	4	Immediately give a tablespoon of common salt or zinc sulphate in a tumbler of warm water
e) Arsenic or antimony salt.	5	(i) Drink plenty of warm water and make vomiting. ii) Give large quantities of freshly precipitated ferric hydroxide (mix equal vols. of FeCl <sub>3</sub> and NH <sub>4</sub> OH) or magnesium hydroxide or castor oil mixed with milk and white of egg. (iii) Keep the feet and abdomen warm by hot waters bottles and blankets.
<b>7. INHALATION</b>		
(a) Bromine or chlorine.		Inhale alcohol or ammonia vapour.
(b) Carbon monoxide.		Fresh air; inhale dilute oxygen.
( c) Nitrous fumes.		Plenty of fresh air; inhale steam
(d) Chloroform.		Fresh air; artificial respiration: apply hot and cold
(e) H <sub>2</sub> S.		Artificial respiration; inhalation of ammonia. Apply warm and cold douches to head.

-----000-----

## ENGINEERING CHEMISTRY LABORATORY(DO'S & DON'T'S)

### DO'S

1. ENTER THE LAB WITH PROPER UNIFORM.
2. WEAR SHOES INSIDE THE LAB.
3. BRING WASTE CLOTH TO THE LAB.
4. KEEP YOUR WORK TABLE CLEAN.
5. HANDLE CHEMICALS CAREFULLY.
6. WASH ALL YOUR APPARATUS BEFORE AND AFTER THE USE.
7. SWITCH OFF THE LAMP, WHEN NOT IN USE.
8. THROW ALL THE WASTAGES INTO THE DUST BIN.
9. USE BLUE FLAME FOR HEATING.
10. USE TEST TUBE HOLDER FOR HEATING.
11. POUR RUNNING WATER TO THE WOUNDS CAUSED BY HEAT OR ACIDS.
12. MEMORISE THE PROCEDURE THOROUGHLY.
13. ANALYSE THE SALT SYSTEMATICALLY.
14. RECORD THE FINDING THEN AND THERE.
15. USE TONGS FOR HANDLING CHINA DISH WHILE HEATING.
16. BE DISCIPLINED INSIDE THE LAB.
17. COMPLETE THE EXPERIMENT WITHIN THE SPECIFIED HOURS.
18. DO THE EXPERIMENT AS PER THE PROCEDURE. NEVER ATTEMPT THE ADDITION OF UNNECESSARY CHEMICALS.
19. **THEN AND THERE GET THE SIGNATURE IN THE OBSERVATION AND RECORD NOTE.**

# ***NOTES***

## DONT'S

1. DON'T CONSULT OTHERS INSIDE THE LAB.
2. DON'T THROW THE SALT WITH RAW HAND ,USE SPATULA.
3. DON'T THROW THE WASTE MATERIALS IN AND AROUND YOUR PLACE.
4. DON'T HANDLE THE CHEMICALS NOT CONCERNING YOU.
5. DON'T WASH THE APPARATUS WHEN IT IS HOT.
6. DON'T HEAT THE TEST TUBE WITH ITS MOUTH DIRECTLY FACING YOU OR YOUR NEIGHBOUR.
7. DON'T HEAT OR BOIL SUBSTANCES WITH CON.H<sub>2</sub>SO<sub>4</sub>.
8. DON'T PLACE HOT CONTAINERS DIRECTLY ON THE WORK BENCH.
9. DON'T REMOVE THE BOTTLE FROM THE SIDE SELF TO YOUR SELF.
10. DON'T THROW ANY SOLID MATERIALS INTO THE SINK.
11. DON'T ENTER OR LEAVE THE LAB WITHOUT PERMISSION.
12. DON'T ADD WATER TO AN ACID. ADD ACID TO WATER.
13. AVOID MISHANDLING OF CHEMICALS AND APPARATUS.
14. DON'T SMELL THE CHEMICALS IN THE LABORATORY.
15. DON'T ATTEMPT TO ADD UNNECESSARY CHEMICALS DURING THE EXPRIMENT.

-----000-----

# ***NOTES***

# ***NOTES***

# ***NOTES***